

2014 Masonite
exterior doors



CANADA EDITION





450 Fenêtre

Porte et fenêtre

Today more than ever, Masonite is relentlessly focused on delivering product, service and design innovations that enhance quality and functionality, creating greater value for our customers throughout the world.

today.

Masonite restructures and emerges with new private ownership. **2009.**

April 6, 2005, Kohlberg Kravis Roberts & Co. acquires Masonite International Corporation. **2005.**

Masonite acquires The Stanley Works residential entry door division. **2004.**

Masonite's largest customer and one of the world's leading door manufacturers, Premdor, Inc., acquires Masonite Corporation from International Paper Company. **2001.**

Masonite enters the door business as a component supplier to the door industry. **1972.**

The John M. Coates Technical Center was built in 1960 as the Company recognized the importance of separating Research & Development from mill operations to focus on new product and process innovation. **1960.**

Masonite's current parent company enters the door business. **1955.**

Masonite goes public with common stock shares listed on the New York Stock Exchange. **1935.**

The Company's name was changed to Masonite Corporation. **1928.**

On September 1, 1925, the corporation was formed and named Mason Fibre Company. **1925.**

Well known researcher and engineer - William H. Mason, changed building materials industry forever by inventing the way wood is used to form more effective building materials. **1924.**





about **Masonite®**

THE MASONITE BRAND

Since 1925, the Masonite name has been known worldwide for its commitment to product innovation, manufacturing excellence and customer service. These qualities and values are as true today as they were more than 80 years ago.

Masonite is constantly expanding its diverse line of interior and exterior doors to meet any design or budget. By combining the long-standing spirit of innovation with customer-focused product development, Masonite continues to be the brand that builders, remodelers and homeowners rely on in their quest to create homes of distinction.

Brands of Masonite's stature don't just happen. They come from years of dedication and a relentless commitment to improvement. That's why Masonite has one of the world's largest private research and development facilities in the door industry. Masonite owns hundreds of international patents, trademarks and applications.

Through a variety of strategic marketing initiatives, the Company is committed to growing the Masonite brand. Masonite believes that a strong brand will bring value to the products used in homes worldwide and increase the business of its customers. It is for these reasons that Masonite stands as one of the greatest brands within the building products industry.



explore the better door



BELLEVILLE® OAK TEXTURED with Element® glass - door BLT404-328-2



more door designs
more glass styles
more value



450-Fenêtre
Porte et fenêtre





BELLEVILLE® HOLLISTER® SMOOTH with Naples® glass - door BLS-404-366-1 - sidelites BLSL-450-366-1







Masonite's Full Line of Entry Doors.....	6	ENERGY STAR.....	34	Door Handing.....	93
How to Choose Your Door.....	8	Decorative Glass.....	36	Door Availability Charts.....	94
Masonite Fiberglass Door Collection		Masonite Codes Defined.....	36	Masonite® Stain Kit.....	100
AvantGuard® Finish & Doors.....	10	Clear Glass.....	82	Glass Availability Charts.....	102
Barrington®		Internal Blinds.....	82		
Traditional.....	14	Venting Lites.....	82		
Craftsman.....	20	External Grille Inserts.....	82		
Flagstaff® & Sierra®.....	22	Internal Grille Inserts.....	84		
Belleville®		SDL (Simulated Divided Lite).....	85		
Textured.....	24	Fast-Frame®.....	86		
Smooth.....	28	Masonite® Patio &			
Oakcraff®.....	30	Flush-Glazed Doors.....	88		
Masonite® HD Steel Door Collection... 32		Masonite® Patio Glass Designs.....	89		



Masonite offers



more door **OPTIONS** with more door **VALUE**

		FIBERGLASS		
		BARRINGTON®		
		TRADITIONAL	SIERRA® & FLAGSTAFF®	CRAFTSMAN
 Rating	★★★★★ Exceptional	★★★★★ Exceptional	★★★★★ Exceptional	★★★★★ Exceptional
 Door & Glass Panel Options	Custom door panel with glass designs	Custom door panel with complementing sidelite glass designs	Custom door panel with glass designs	Custom door panel with glass designs
 Woodgrain Texture	Traditional oak & mahogany with variable-depth woodgrain	Traditional & ribbon-striped mahogany with variable-depth woodgrain	Rift-cut oak & traditional mahogany with variable-depth woodgrain	
 Door Core	Polyurethane	Polyurethane	Polyurethane	
 ENERGY STAR® Eligible*	✓	✓	✓	
 Finish Options	Stain or Paint	AvantGuard® Prefinished, Stain or Paint	Stain or Paint	
 Warranty	Limited Lifetime Warranty†	Limited Lifetime Warranty† 5 Year for AvantGuard® Finish†	Limited Lifetime Warranty†	

We bring you more styles, designs, textures and sizes to choose from for your home. Homeowners, remodelers, architects and builders rely on Masonite for superior craftsmanship, durability and value in both fiberglass and steel doors. Choose from our extensive line of entry doors to make all your entrances grand.

Traditional



Rich, classic elite line offers superior woodgrain authenticity with excellent durability and performance.

Sierra®



Southwest and country inspired designs in our superior woodgrain motif engineered for excellent durability and performance.

Flagstaff®

Craftsman



Crafted in Mission style with your choice of our superior woodgrain texture engineered for excellent durability and performance.

*A critical component of an ENERGY STAR qualified entryway.
 †All warranties are limited.
 ‡Belleville Mahogany has premium hardwood stiles.

ENGINEERED TO LAST A LIFETIME

FIBERGLASS					
BELLEVILLE®		OAKCRAFT®		STEEL	
TEXTURED	SMOOTH	OAKCRAFT®		STA-TRU®	MASONITE HD
★★★★ Excellent	★★★ Best	★★★ Best		★★ Good	
Over 100 customizable door and glass designs		Over 100 customizable door and glass designs		Over 100 customizable door and glass designs	
Traditional oak, fir & ribbon-stripped mahogany with variable-depth woodgrain		Smooth		Traditional oak with single-depth woodgrain	
Smooth		Polyurethane		Smooth	
Polyurethane		Polyurethane		Polyurethane	
✓		✓		✓	
AvantGuard® Prefinished, Stain or Paint*		AvantGuard® Prefinished, Paint		Stain or Paint	
Prefinished white		Paint		Prefinished white	
Limited Lifetime Warranty† 5 Year for AvantGuard® Finish†		Limited 25 Year Warranty†		Limited 20 Year Warranty†	
				Limited 5-15 Year Warranty†	



Textured

Smooth

Mix and match high-performing natural woodgrain textured or smooth door designs with your choice of decorative glass.



Oakcraft®

Sleek look with a variety of door and glass options to choose from, engineered for performance.



Sta-Tru®

Masonite HD

High-definition panel profile offers the security of steel for years of performance.

See more door design options.
Visit our beautiful door designer at masonite.com.

how to choose your door

1

what's your **style**?

Select from our vast line of traditional, contemporary or modern designs from 1 panel to 9 panel patterns, with or without decorative glass elements.



configuration
options



2

what **glass design** do you want?



See the glass section to view all glass designs and sizes available.



3 choose your material



species **BMT** Belleville® Mahogany Textured **BLT** Belleville® Oak Textured **BFT** Belleville® Fir Textured
BLS Belleville® Smooth **OAK** Oakcraft® **SHD** Sta-Tru® HD Steel **MHD** Masonite® HD Steel



FIBERGLASS

Engineered to Last a Lifetime

- proprietary, high-performance fiberglass doors are specially engineered to provide maximum protection and durability
- looks like real wood & insulates 5X better*
- available in mahogany, oak and fir woodgrain textures or a smooth finish
- smooth can be painted and textured best stained
- ideal for coastal applications
- will not dent or rust, plus resists splitting, cracking and warping

- square-edge, engineered stiles provide excellent dimensional stability for harsh weather climates
- reinforced lock block provides strength and security for door hardware
- high-quality composite wood bottom rails are rot and corrosion resistant
- backed by a Limited Lifetime Warranty



STEEL

High-Performance Steel

- durable, secure and long lasting
- resists rotting, splitting and cracking

- insulates better than wood*
- smooth finish
- easy to paint



*Based on insulating characteristics of polyurethane foam core compared to wood.

AvantGuard[®] finish



Spanish Cedar

6'8"



Flagstaff[®] plank
BAC-P



Sierra[®] 2 panel plank camber-top
BAC-2P



Sierra[®] 2 panel plank camber-top arch-top
BAC-2R



full lite w/BR2
BACSL-154-BR2-X



full lite w/Chord
BACSL-154-115-X



full lite w/
Pear
BACSL-154-116-X



full lite w/clear
BACSL-154-LEA-X

8'0"



Flagstaff[®] plank
BAC-P



Sierra[®] 2 panel plank camber-top
BAC-2P



Sierra[®] 2 panel plank camber-top arch-top
BAC-2R



full lite w/BR2
BACSL-853-BR2-X



full lite w/
Chord
BACSL-853-115-X



full lite w/Pear
BACSL-853-116-X



full lite w/clear
BACSL-853-LEA-X

Door Finish

CRITERIA	STAINED* WOOD	AVANTGUARD [®]	STAINED* FIBERGLASS
Appearance Authenticity	High	High	Medium
Top Coating Required	Yearly	After 5 Years	After 2-3 Years
Finish Warranty	1 Year	5 Year	2+ Years
ENERGY STAR Eligible **	No	Yes	Yes
Weatherability	Low	High	Medium

*Stained finish refers to a conventional stain and topcoat system. Finish warranty may vary by product supplier.

**See page 34 for more details.

Note: AvantGuard sidelites with clear glass are standard Low-E and argon-filled for optimum thermal performance.

The Fusion of Wood & Fiberglass

Some would call a beautiful wood door with little to no maintenance a dream. We call it AvantGuard.

Sidelite Glass Options:



BARRINGTON® SIERRA® & FLAGSTAFF® DESIGNS

Black Walnut

6'8"



Flagstaff® plank
BLW-P



Sierra® 2 panel
plank camber-top
BLW-2P



Sierra® 2 panel plank
camber-top arch-top
BLW-2R



full lite w/BR2
BLWSL-154-BR2-X



full lite w/
Chord
BLWSL-154-115-X



full lite w/Pear
BLWSL-154-116-X



full lite w/clear
BLWSL-154-LEA-X

8'0"



Flagstaff® plank
BLW-P



Sierra® 2 panel
plank camber-top
BLW-2P



Sierra® 2 panel plank
camber-top arch-top
BLW-2R



full lite w/BR2
BLWSL-853-BR2-X



full lite w/
Chord
BLWSL-853-115-X



full lite w/Pear
BLWSL-853-116-X



full lite w/clear
BLWSL-853-LEA-X



450-Fenêtre
Porte et fenêtre

5 Layers of Defense

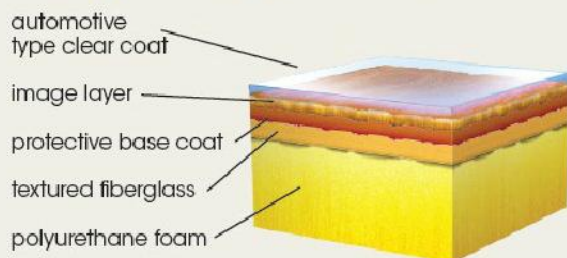

Note: Above diagram not to scale

BAC Barrington® AvantGuard® Spanish Cedar

BLW Barrington® AvantGuard® Black Walnut

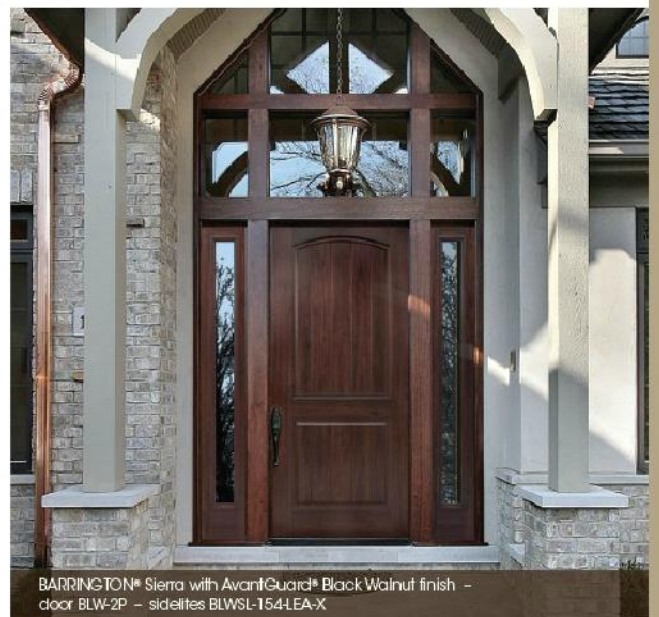

BARRINGTON® Sierra with AvantGuard® Black Walnut finish -
door BLW-2P - sidelites BLWSL-154LEA-X

AvantGuard[®] finish



BELLEVILLE[®] HOLLISTER[®] with AvantGuard[®] Cherry Finish and Alston[®] glass - door BLC-304-338-2

Cherry

6'8"



2 panel square-top
BLC-2ST



6 panel
BLC-6



1 panel w/Element
1/2 lite
BLC-106-328-1



2 panel w/Element
1/2 lite
BLC-106-328-2



Hollister[®] 2 panel
w/Alston
3/4 oval lite
BLC-304-338-2



Hollister[®] 1 panel
w/Element
3/4 rectangle lite
BLC-404-328-1



1 panel
w/Element
1/2 lite
BLC-129-328-1



full lite
w/Alston
BLC-152-338-X



1 panel w/
Element
3/4 lite
BLC-450-328-1

Available Glass Options:

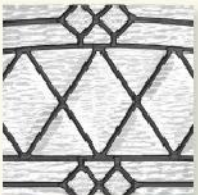

Alston[®] 338



Element[®] 328



Sienna[®] 817



Clear LEA (only sidelites)

Unlike any other door, AvantGuard perfectly blends beauty and durability into one patented package by combining the aesthetics of wood with the durability of fiberglass.

	6'8"								
Cherry	BLC-2ST	BLC-6	BLC-106-1	BLC-106-2	BLC-304-2	BLC-404-1	BLC-129-1	BLC-152-X	BLC-450-1
Panel	-	-							
Alston 338			•	•	•	•	•	•	•
Element 328			•	•		•	•		•
Sienna 817			•	•	•	•	•	•	•
Clear LEA							•	•	•

BELLEVILLE® PANEL DESIGNS

Black Walnut



	6'8"					
Black Walnut	BLW-6	BLW-304-2	BLW-404-1	BLW-106-2	BLWSL-129-1	BLWSL-450-1
Panel	*					
Alston 338		*	*	*	*	*
Element 328			*	*	*	*
Sienna 817		*	*	*	*	*
Clear LEA					*	*

	8'0"				
Black Walnut	BLW-6	BLW-306-2	BLW-122-1	BLW-404-2	BLWSL-852-X
Panel	*				
Alston 338		*	*	*	
Element 328				*	
Sienna 817			*	*	*
Clear LEA					*

Belleville® Hollister® with AvantGuard® Black Walnut finish and Alston® glass BLW-304-338-2



BLC Belleville® AvantGuard® Cherry
BLW Belleville® AvantGuard® Black Walnut

Note: AvantGuard sidelites with clear glass are standard Low-E and argon-filled for optimum thermal performance.

* Not available in 3'6" width

Designer

Woodgrain fiberglass



BARRINGTON® MAHOGANY TEXTURED with BR2 glass - door BRM-303-BR2-2V - transom C38-900

The essence of luxury & performance
Featuring exquisite raised moulding panel profiles for an upscale look.

TRADITIONAL DOOR STYLES

Authentic Woodgrain Texture

- composite door surface replicates an authentic mahogany or oak door appearance
- features Masonite's variable-depth, realistic, woodgrain texture
- finishes easily and beautifully

Distinct Raised Moulding

- raised moulding creates beautiful shadow lines
- panels are recessed below the surface at the stiles & rails
- adds visual depth and character

Oversized Lock Block

- lock area is reinforced to accommodate premium door hardware

Stain-Grade Matching Hardwood Stiles

- built with true square-edge construction
- engineered oak or mahogany capped stiles

Glass Frame Profiles

- designed to match the panel moulding for a consistent appearance

Factory-Glazed Doors & Sidelites

- yields wider glass and narrower stiles & rails without unsightly screw plugs



BARRINGTON® OAK TEXTURED with BR4 glass – door BAR-303-BR4-2V – sidelites BARS-L451-BR4-1

Traditional door styles

Barrington® Doors with BR4 Glass



6'8"
 2 panel 3/4 oval lite oak BAR-303-BR4-2V
 2 panel 3/4 oval lite mahogany BRM-303-BR4-2V
 2 panel 3/4 rectangle lite oak BAR-405-BR4-2
 2 panel 3/4 rectangle lite mahogany BRM-405-BR4-2



BR4 Glass
antique black casing
low-e argon construction



6'8"
 3 panel 1/2 camber-top lite oak BAR-411-BR4-3
 1 panel 3/4 lite oak BARSL-451-BR4-1
 1 panel 3/4 lite mahogany BRMSL-451-BR4-1
 full lite oak BARSL-154-BR4-X

BR4 brings contemporary styling to Barrington doors.



8'0"
 2 panel 3/4 rectangle lite oak BAR-123-BR4-2
 2 panel 3/4 oval lite oak BAR-302-BR4-2V
 2 panel 3/4 oval lite mahogany BRM-302-BR4-2V
 3 panel 1/2 camber-top lite oak BAR-412-BR4-3
 1 panel 3/4 lite oak BARSL-153-BR4-1
 1 panel 3/4 lite mahogany BRMSL-153-BR4-1
 full lite oak BARSL-853-BR4-X

BAR Barrington® Oak Textured BRM Barrington® Mahogany Textured

Barrington® Doors with BR3 Glass



BR3 Glass
platinum caming

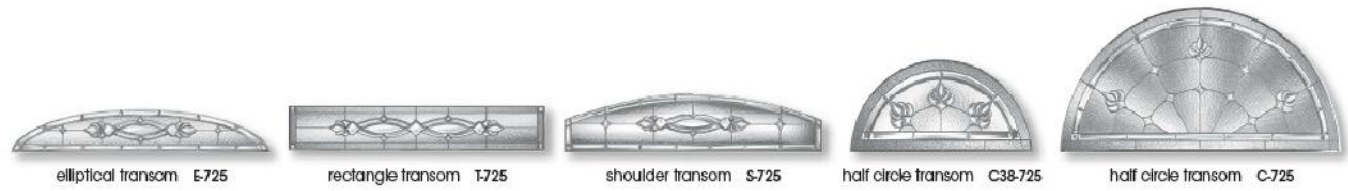

Traditional door styles

Barrington® Doors with BR2 Glass

6'8"



7 panel center arch lite oak BAR-204-BR2-7
1 panel full oval lite oak BAR-301-BR2-1
2 panel 3/4 oval lite oak BAR-303-BR2-2V
2 panel 3/4 oval lite mahogany BRM-303-BR2-2V



6'8"



2 panel 3/4 rectangle lite oak BAR-405-BR2-2
2 panel 3/4 rectangle lite mahogany BRM-405-BR2-2
3 panel 1/2 camber-top lite oak BAR-411-BR2-3
1 panel 3/4 lite oak BARSL-451-BR2-1
1 panel 3/4 lite mahogany BRMSL-451-BR2-1
full lite oak BARSL-154-BR3-X

BR2 Glass
antique black caming

8'0"



2 panel 3/4 rectangle lite oak BAR-123-BR2-2
7 panel center arch lite oak BAR-205-BR2-7
2 panel 3/4 oval lite oak BAR-302-BR2-2V
2 panel 3/4 oval lite mahogany BRM-30-BR22-2V
3 panel 1/2 camber-top lite oak BAR-412-BR2-3
1 panel 3/4 lite oak BARSL-153-BR21
1 panel 3/4 lite mahogany BRMSL-153-BR2-1
full lite oak BARSL-853-BR2-X

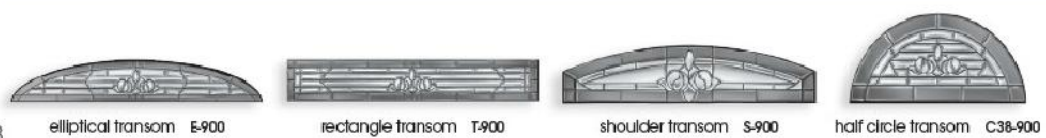

BAR Barrington® Oak Textured BRM Barrington® Mahogany Textured

Barrington® Doors with CB1 Glass



2 panel 3/4 oval lite oak BAR-303-CB1-2V
 2 panel 3/4 oval lite mahogany BRM-303-CB1-2V
 2 panel 3/4 rectangle lite oak BAR-405-CB1-2
 2 panel 3/4 rectangle lite mahogany BRM-405-CB1-2



CB1 Glass
clear beveled

Clear transoms also available



3 panel 1/2 camber-top lite oak BAR-411-CB1-3
 1 panel 3/4 lite oak BARSL-451-CB1-1
 1 panel 3/4 lite mahogany BRMSL-451-CB1-1



BARRINGTON® MAHOGANY TEXTURED with CB1 glass - door BRM-303-CB1-2V - sidelites BRMSL-451-CB1-1

Craftsman fiberglass



BARRINGTON® CRAFTSMAN OAK TEXTURED with CBT glass - door BRC-226-CBT3

Mission Styled Doors

Unmatched craftsmanship for an authentic wood look

BRC Barrington® Craftsman Oak BCM Barrington® Craftsman Mahogany

Barrington® Craftsman Doors with BS1 Glass



Authentic Woodgrain Texture

- composite door surface replicates an authentic mahogany or oak door appearance
- features Masonite's variable depth, realistic, woodgrain texture
- finishes easily and beautifully

Oversized Lock Block

- lock area is reinforced to accommodate premium door hardware

Stain-Grade Matching Hardwood Stiles

- assembled with true square-edge construction

Profile Alignment

- recessed panels align perfectly with glass placement
- Shaker sticking and recessed flat panels replicate a true Mission design

Custom Glazing

- glass is integrated into door design — creating a simple, clean Mission style
- flat caming for authentic craftsman look (CBT & CBH)

Optional Dentil Shelves & SDL Lite Kits

- customize the door style with dentil shelf or simulated divided lite kits

Other Available Glass Options:

BC4 Glass

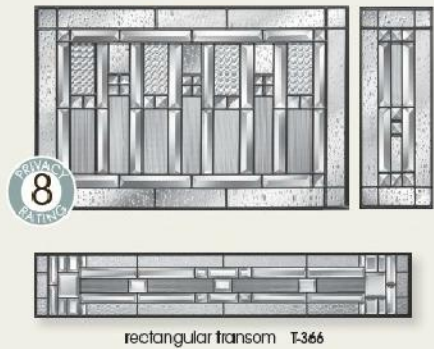

BC5 Glass

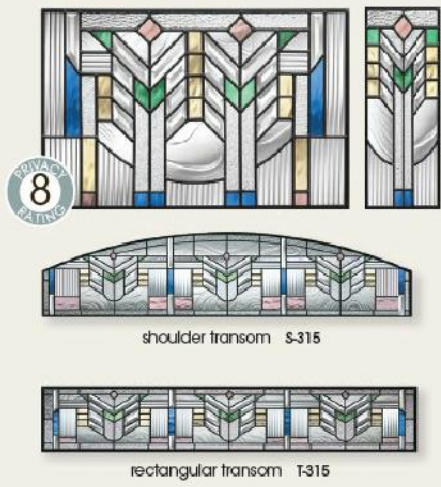

CBT Glass



CBH Glass



*Upgrade clear glass to Low-E and argon-filled (LEA) to increase thermal performance and savings.

Sierra® & Flagstaff®

Mahogany Texture

- fiberglass facing with beautiful Masonite mahogany texture

Oversized Lock Block

- lock area is reinforced to accommodate premium door hardware

Stain-Grade Matching Mahogany Stiles

- finished with true square-edge construction

Factory-Glazed Sidelites

- yields wider glass and narrower stiles & rails without unsightly screw plugs



BARRINGTON® SIERRA 1 panel plank cambertop arch-top – BSP-TR



BARRINGTON® FLAGSTAFF® plank – door BFS-P – sidelite BSNSL-154-116-X

Southwestern Inspired with
a Rustic Flair Design

Gentle arches & soft planking
lines create an extraordinary look.

fiberglass

BSP Barrington® Sierra® Plank BSN Barrington® Sierra® No Plank BFS Barrington Flagstaff®

Barrington® Sierra® & Flagstaff® 6'8"



Sierra®
2 panel plank
camber-top
BSP-2P

Sierra®
2 panel
camber-top
BSN-2CT

Sierra®
2 panel plank camber-
top arch-top
BSP-2R

Sierra®
2 panel camber-top
arch-top
BSN-2R

Sierra®
1 panel plank
camber-top
BSP-1

Sierra®
1 panel plank camber-
top arch-top
BSP-1R

Flagstaff®
plank
BFS-P

8'0"



Sierra®
2 panel
plank camber-top
BSP-2P

Sierra®
2 panel
camber-top
BSN-2CT

Sierra®
2 panel plank camber-
top arch-top
BSP-2R

Sierra®
2 panel camber-top
arch-top
BSN-2R

Sierra®
1 panel
plank camber-top
BSP-1

Sierra®
1 panel plank camber-
top arch-top
BSP-1R

Flagstaff®
plank
BFS-P

8'0"

6'8"



Sierra®
BR2
full sidelite
BSNSL-154-BR2-X

Sierra®
BR3
full sidelite
BSNSL-154-BR3-X

Sierra® clear*
glass full
sidelite
BSNSL-154-BS1-X

Sierra® Iron
Springs® glass
full sidelite
BSNSL-154-918-X

Sierra® Pear
glass full
sidelite
BSNSL-154-116-X

Sierra®
BR2
full sidelite
BSNSL-853-BR2-X

Sierra®
BR3
full sidelite
BSNSL-853-BR3-X

Sierra® clear*
glass full
sidelite
BSNSL-853-BS1-X

Sierra® Iron
Springs® glass
full sidelite
BSNSL-853-918-X

Sierra® Pear
glass full
sidelite
BSNSL-853-116-X

*Upgrade BS1 clear glass to Low-E and argon-filled (LEA) to increase thermal performance and savings.

Premium

Woodgrain fiberglass

MAHOGANY

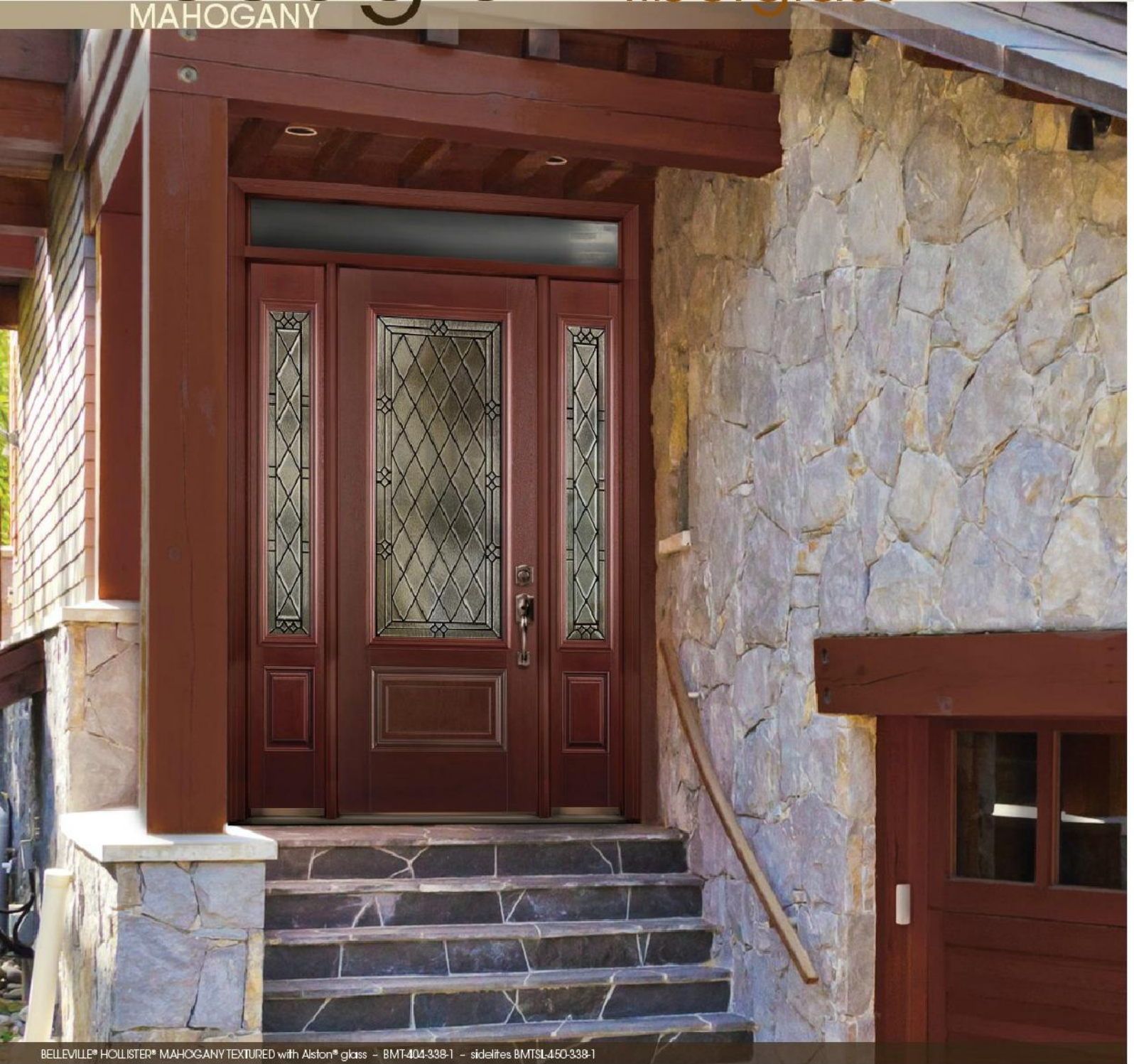

BELLEVILLE® HOLLISTER® MAHOGANY TEXTURED with Alston® glass - BMT-404-338-1 - sidelites BMTSL-450-338-1

Make it great with your choice of glass

A great combination of real wood door appearance
with the long-lasting performance of fiberglass.

100s OF CUSTOMIZABLE DOOR PANEL & GLASS OPTIONS

Belleville® Mahogany Textured



Real Wood Appearance

- premium variable-depth oak, fir or ribbon-striped mahogany grain textures create the look of natural wood
- finishes easily and beautifully

High-Definition Profile Panels

- adds architectural interest and elegance

Large Reinforced Lock Block

- provides added strength and security for door hardware

True Square-Edge Construction

- creates the most authentic wood door appearance

Stain-Grade Matching Mahogany Stiles

- a premium feature on our Belleville® mahogany line

BMT Belleville® Mahogany Textured



BELLEVILLE® MAHOGANY TEXTURED with Panama® glass - door BMT-203-725-7

Premium

Woodgrain fiberglass

OAK & FIR



Belleville® Oak Textured

6'8"



flush oak
BLT-X



1 panel arch oak
BLT-1



2 panel square-top oak
BLT-2ST



Craftsman 2 panel oak & optional dentil shelf
BLT-2C



3 panel arch-top oak
BLT-3



4 panel blank-top oak
BLT-4BT



4 panel New England oak
BLT-4NE



6 panel blank-top oak
BLT-6BT



6 panel oak
BLT-6



6 panel camber-top oak
BLT-6CT



8 panel Parliament oak
BLT-8



2 panel universal oak
BLTSL-2



Craftsman 1 panel oak
BLTSL-1C

8'0"



flush oak
BLT-X



2 panel oak
BLT-2ST



6 panel oak
BLT-6



8 panel Parliament oak
BLT-8



2 panel universal oak
BLTSL-2

BLT Belleville® Oak Textured BFT Belleville® Fir Textured

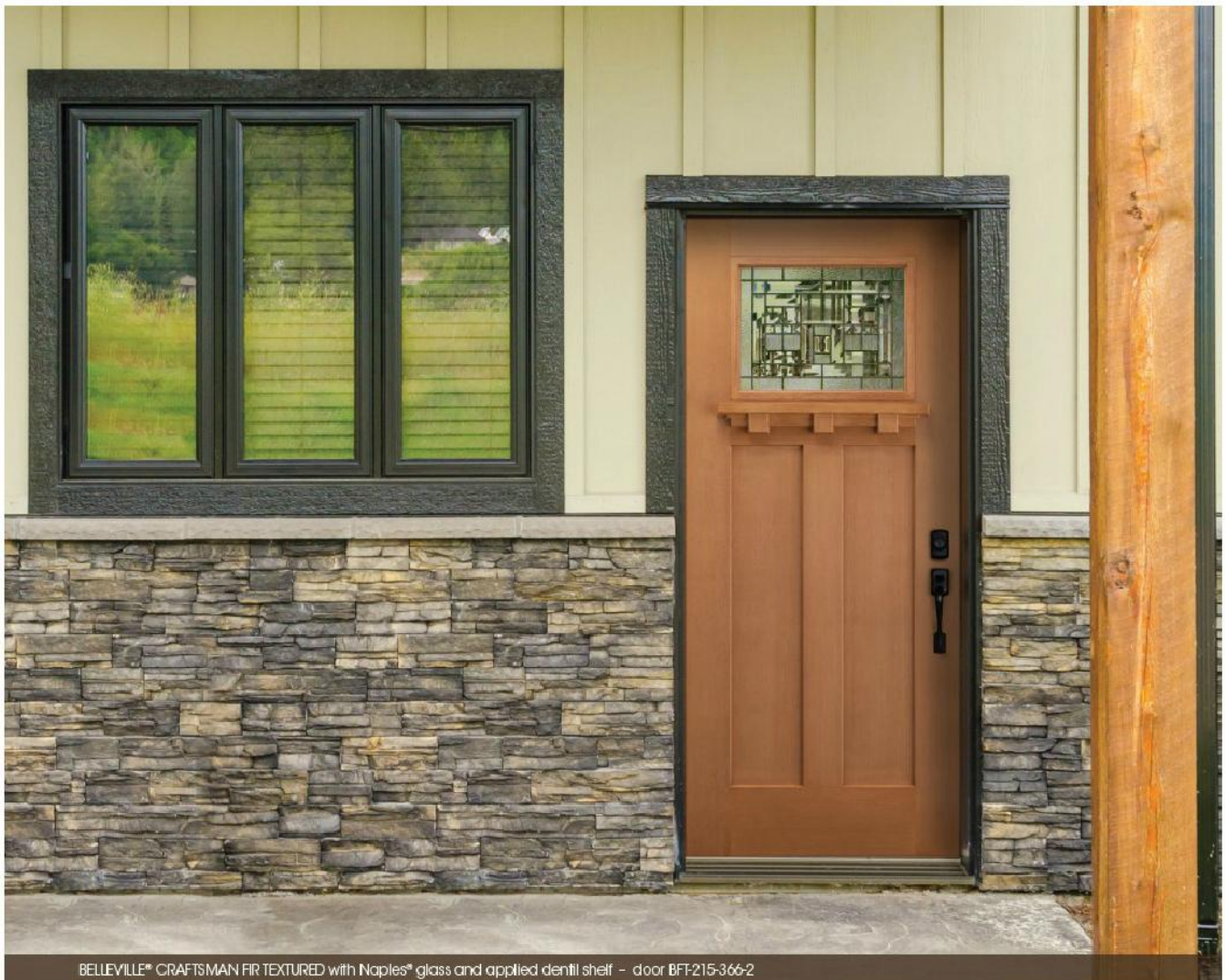

BELLEVILLE® CRAFTSMAN FIR TEXTURED with Naples® glass and applied dentil shelf - door BFT-215-366-2

Belleville® Fir Textured

Real Wood Appearance

- premium deep, straight grain texture provides a true fir grain wood look
- finishes easily and beautifully

True Square-Edge Construction

- creates the most authentic wood door appearance

High Definition Profile Panels

- adds architectural interest and elegance



Craftsman 2 panel
fir & optional
dentil shelf
BFT-2C



Hollister®
2 panel fir
BFT-2



6 panel fir
BFT-6



2 panel universal
fir
BFTSL-2



Craftsman
1 panel fir
BFTSL-1C



Premium

Smooth fiberglass

High-Performance Smooth Surface

- ideal for painting and will not rust or dent

High-Definition Panel Profile

- adds architectural appeal and elegance

Square-Edge Construction

- provides an authentic wood door appearance

Reinforced Lock Block

- provides strength and security for door hardware

Rot-Resistant Bottom Rails

- high-quality composite bottom rails are rot and corrosion resistant



High Performance Fiberglass

High-definition profiles capture the beauty and elegance of real wood.

Belleville® Smooth

6'8"



flush
BLS-X



2 panel square-top
BLS-2ST



2 panel roman
BLS-2R*

new



Cheyenne® 2 panel plank camber-top
BLS-2P



4 panel New England
BLS-4NE



6 panel blank-top
BLS-6BT



6 panel
BLS-6

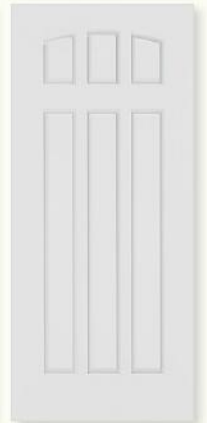

6 panel camber-top
BLS-6CT

8'0"



flush
BLS-X



2 panel square-top
BLS-2ST



2 panel roman
BLS-2R*

new



Cheyenne® 2 panel plank camber-top
BLS-2P

*Bottom rail meets all accessibility requirements.

100s OF CUSTOMIZABLE DOOR PANEL & GLASS OPTIONS



Hollister® 2 panel BLS-2 Craftsman 2 panel & optional dentil shelf BLS-2C 3 panel arch-top BLS-3 4 panel blank-top BLS-4BT



8 panel Parliament BLS-8 2 panel universal BLSL-2 Craftsman 1 panel BLSL-1C flush BLSL-X



Hollister® 2 panel BLS-2 6 panel BLS-6 8 panel Parliament BLS-8 2 panel universal BLSL-2



BELLEVILLE® SMOOTH with Iron Springs® glass – door BLS-122-918-X

Oakcraft® fiberglass



OAKCRAFT® with Cuzco® glass - door OAK-106-364-2 - sidelites OAKSL-129-364-1

Standard Oak Grain Look

Enjoy an economical option with low maintenance.

100s OF CUSTOMIZABLE DOOR PANEL & GLASS OPTIONS

Oakcraft®

6'8"



flush
OAK-X



3 panel arch-top
OAK-3



4 panel blank-top
OAK-4BT



4 panel New England
OAK-4NE



6 panel
OAK-6



9 panel
OAK-9



flush
OAKSL-X



1 panel
OAKSL-1



1 panel with
3/4 life cutout
OAKSL-1

8'0"



flush
OAK-X



6 panel
OAK-6



flush
OAKSL-X



1 panel
OAKSL-1

High-Performance Fiberglass

- proprietary door facings are specially engineered to provide maximum protection and durability
- adds architectural appeal and elegance

Square-Edge Construction

- provides an authentic wood door appearance

Reinforced Lock Block

- provides strength and security for door hardware

Rot-Resistant Bottom Rails

- high-quality composite bottom rails are rot and corrosion resistant

Oakcraft® 3 panel arch-top with Woodbridge® glass - door OAK-304-423-3

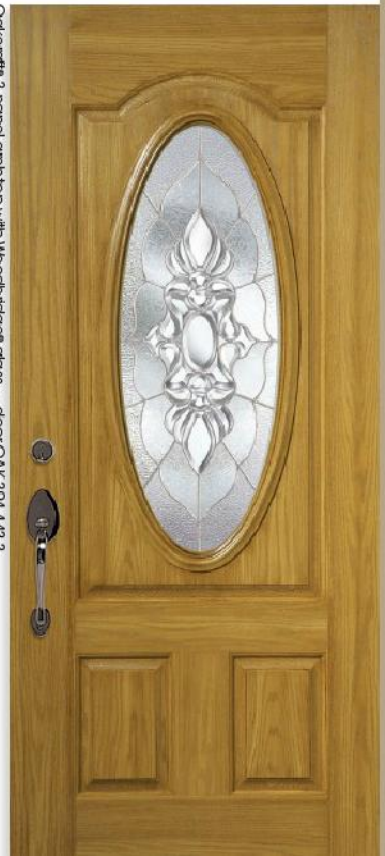

Premium Steel



Steel-Edge

STA-TRU® HD LIMITED 20 YEAR WARRANTY
MASONITE® HD LIMITED 15 YEAR WARRANTY

Wood-Edge

STA-TRU® HD LIMITED 20 YEAR WARRANTY
MASONITE® HD LIMITED 5 YEAR WARRANTY
MASONITE® UTILITY LIMITED 1 YEAR WARRANTY

Masonite Steel doors feature high-definition decorative panel profiles that closely replicate the appearance of a high-end wood door with the ultimate in security. They truly make a statement with the addition of Masonite's glass inserts for a grand entrance.



MASONITE® STA-TRU® HD with Kordella® glass - door SHD-404-686-1 - sidelites SHDSL-450-686-1

Standard features for steel-edge & wood-edge

- 1 **High-Definition Panel Profile**
 - creates excellent shadow lines and distinct panel designs
- 2 **Internal Blocking**
 - lock area is reinforced to provide solid mounting surface
- 3 **Two Finish Options**
 - Masonite® HD features a baked-on primer for a more durable finish
 - Sta-Tru® HD has a prefinished white surface (no initial finishing required on door panel)
- 4 **Rot-Resistant Bottom Rail**
 - high-performance composite material is utilized on all bottom rails

Steel-Edge features

- 5 **Interlocking Steel-Edge**
 - has six 90° steel bends in each edge to ensure stability and resist warping
- 6 **Square-Edge Design**
 - wood door appearance
- 7 **Vinyl Extrusion**
 - locks facings together and provides an insulated thermal barrier
- 8 **Steel Reinforcements**
 - hinges are flush mounted into steel reinforcements to help prevent hinge sag
 - 90-minute fire label available (opaque doors only)

Wood-Edge features

- 9 **Engineered Construction**
 - finger-jointed hinge stile
 - laminated lumber lock stile
- 10 **Interlocking Design**
 - grooved stiles add strength and structural rigidity
 - steel facings wrap over stiles with a 'J' bend
 - 20-minute fire label available (opaque doors only)



High Definition Steel

High-Definition profiles provide curb appeal and durability.

Sta-Tru® & Masonite High-Definition Steel Designs

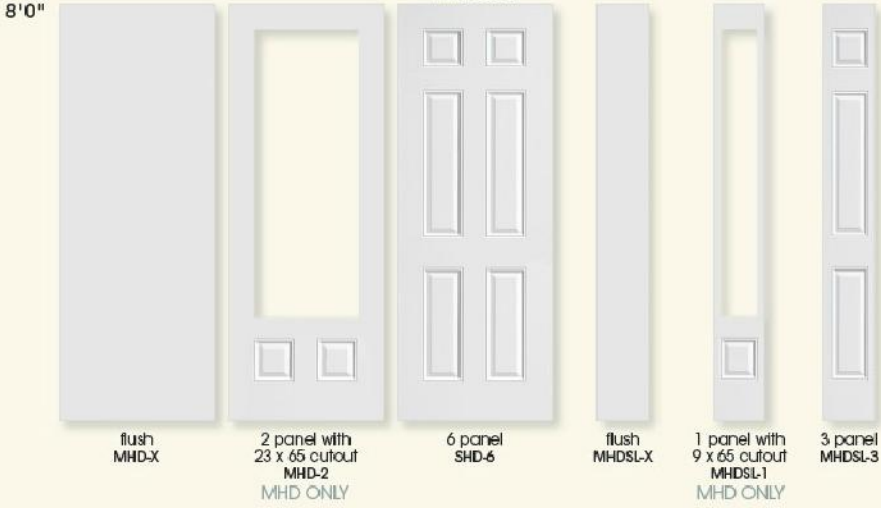

Masonite Utility Steel Designs

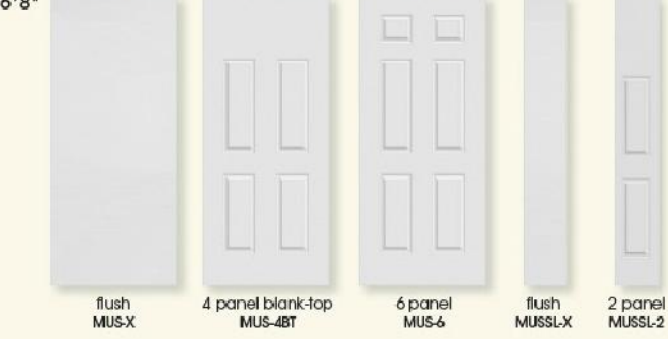

SHD Sta-Tru® High-Definition Prefinished Steel
MHD Masonite® High-Definition Steel
MUS Masonite® Utility Steel

Door images shown in white can be customized with a wide variety of paint colors.

Q1 Available Q1 2014





ENERGY STAR®



ENERGY STAR is a government backed program to help consumers identify energy efficient products. It is a voluntary program administered by Natural Resource Canada. Products that do qualify should be labeled with an ENERGY STAR label.

Canada is broken out into different zones, so the level of performance required differs based on where you live. This map shows the Canadian Zones.

In order to be ENERGY STAR qualified, performance of the system must meet U-factor and the SHGC (Solar Heat Gain Coefficient) criteria.

1 U-Factor: Measures the rate of heat transfer through a product. It considers all elements of an assembly including conductivity, air flow, and glass emissivity. A lower U-Factor indicates a better insulating product.

2 SHGC (Solar Heat Gain Co-efficient): Measures the amount of energy that passes through glass from the sun. For most homes, a higher SHGC value will help offset your overall energy costs.

Although entry systems are manufactured as one unit, doors and sidelites carry individual performance levels and thus are labeled separately. A fully ENERGY STAR certified system has labels on all sections of the unit.

The chart below will help you identify if your Masonite Entry System can qualify for ENERGY STAR in your area.

			ENERGY STAR Qualification Chart										
			no glass	1/4 lite	1/2 lite	3/4 lite	full lite	1/2 sidelite	3/4 sidelite	full sidelite	transom	1/2 sidelite	full sidelite
GLASS DEFINITION			135, 137, 203	105, 106, 107, 304, 306	404	122	129, 200	450	152	elliptical, rectangular	DIRECT GLAZED		
Steel Doors	Clear Low-E Glass	ZONE A	✓	✓	✓	✓	✓	✓	✓				
		ZONE B	✓	✓	✓	✓	✓	✓	✓				
		ZONE C	✓	✓	✓	✓	☐	✓	✓	✓*			
	Decorative Glass	ZONE A	✓	✓	✓	✓	✓	✓	✓	✓			
		ZONE B	✓	✓	✓	✓	✓	✓	✓	✓			
		ZONE C	✓	✓	✓	✓	☐	✓	✓	☐			
Fiberglass Doors	Clear Low-E Glass	ZONE A	✓	✓	✓	✓	✓	✓	✓				
		ZONE B	✓	✓	✓	✓	✓*	✓	✓	✓*			
		ZONE C	✓	✓	✓	✓*	☐	✓	✓*				
	Decorative Glass	ZONE A	✓	✓	✓	✓	✓	✓	✓	✓			
		ZONE B	✓	✓	✓	✓	☐	✓	✓	☐			
		ZONE C	✓	✓	✓	☐	☐	✓	☐				

✓ ENERGY STAR qualified ✓* Requires Low-E and Argon to be ENERGY STAR qualified
 ☐ This glass can be made Zone C eligible, upgrade charges will apply. Contact your customer service representative for more details.

Door Performance Criteria		
U-Factor		
ZONE	HEATING DEGREE-DAY RANGE	maximum U-Factor W/m ² ·K (Btu/h·ft ² ·°F)
ZONE A	<=3500	1.80 (0.32)
ZONE B	> 3500 to <=5500	1.60 (0.28)
ZONE C	> 5500 to <=8000	1.40 (0.25)
ZONE D	>8000	1.20 (0.21)



* Data is accurate at time of printing and is subject to change. ENERGY STAR is a registered trademark of the U.S. EPA and is administered in Canada by Natural Resources Canada.

Visit masonite.com for more information.



MASONITE® HD STEEL with Naples® glass - door SHD-21 7-366-X - sidelite SHDSL-1 52-366-X



transforming
light into
brilliance

Decorative glass embraces natural light and transforms any entryway into a vision of beauty without compromise. So add charm and sophistication to your home's entry, inside and out, with one of our superbly crafted glass designs offered in a variety of configurations. The choice is yours.

Masonite® codes defined



SL = sidelite

BLTSL-450-817-1

BLT - 106 - 817 - 1

**** door acronym
**** glass shape & size
**** glass design & coming
**** # visible door panels

2236 = glass dimensions 22" x 36"

BLT-106-817-1
2236

Glass Lite Size & Shape

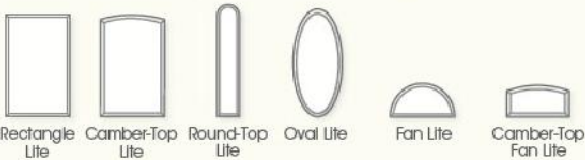

106 22" x 36" Rectangle	152 7' x 64" Rectangle	304 16" x 40" Oval
107 22" x 37-1/2" Camber-Top	201 8" x 58" Round-Top	306 15" x 55" Oval
122 22" x 64" Rectangle	203 8" x 42" Round-Top	404 22" x 48" Rectangle
129 8" x 36" Rectangle	215 22" x 16" Rectangle	450 8" x 48" Rectangle
135 22" x 10" Fan	217 22" x 17" Rectangle	615 8" x 16" Rectangle
136 7-1/2" x 18-1/2" Rectangle	228 22" x 10" Rectangle	810 22" x 80" Rectangle
137 22" x 10" Camber-Top Fan	300 20" x 57" Oval	852 8" x 80" Rectangle
151 8" x 64" Rectangle		

Visible Door Panels

Sample selection of door panels shown

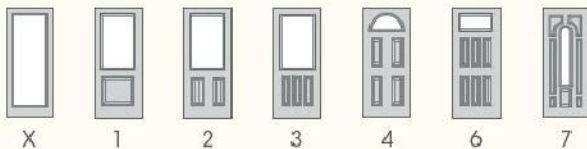

Door Acronym



BMT Belleville® Mahogany Textured

BLT Belleville® Oak Textured

BFT Belleville® Fir Textured

BLS Belleville® Smooth

OAK Oakcraft®

SHD Sta-Tru® HD Steel

MHD Masonite® HD Steel

raise your glass

Elevate the look of your entry door with Masonite's extensive line of distinctive glass styles. Explore dozens of textures, coming options, sizes, and styles in our decorative glass collection, or opt for the elegant simplicity of clear glass with internal blinds, venting inserts, grilles or simulated divided lites (SDLs).

From the elegant textured diamonds of Alston® to the contemporary configurations of Zavalla®, Masonite decorative glass inserts will raise your entryway to a whole new level of sophistication.

Alston® 338.....	38	Panama® 724-725.....	68
Aria® 455.....	40	Pear 116.....	70
Aurora™ 207.....	42	Quattro® 957.....	72
Brise® 269.....	44	Rockland® 566.....	74
Chord 115.....	46	Sienna® 817.....	76
Cuzco® 364.....	48	Woodbridge® 442-443.....	78
Element® 328.....	50	Zavalla® 537.....	80
Georgian® 515-517-518.....	52		
Glace® 430-433.....	54	CLEAR	
Iron Springs® 918.....	56	Internal Blinds.....	82
Kordella® 686.....	58	Venting Inserts.....	82
Madrid® 900.....	60	External Grille Inserts.....	82
Marquise® 777-778-779.....	62	One Lite Inserts.....	83
Mondrian® 833.....	64	Internal Grille Inserts.....	84
Naples® 366.....	66	Simulated Divided Lites.....	85

www.masonite.com

Visit our website and be amazed how **easy** it is to create the entrance that will reflect your style.

decorative
glass
options



Alston®



Aria®

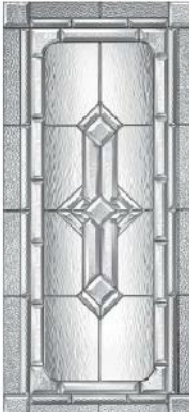

Aurora®



Brise®



Chord



Cuzco®



Element®



Georgian®



Glaze®

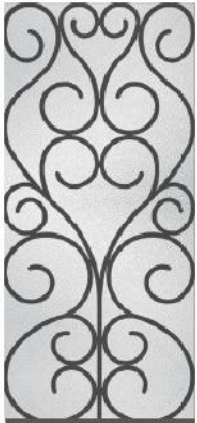

Iron Springs®



Kordella®

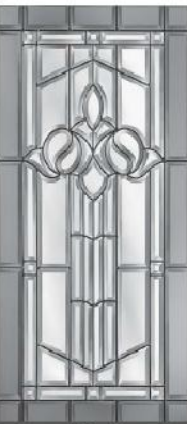

Madrid®



Marquise®



Mondrian®

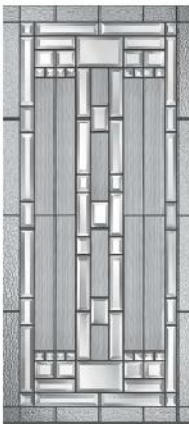

Naples®



Panama®



Pear



Quattro®



Rockland®



Sienna®



Woodbridge®



Zavalla®

Please note, due to the limitations of the printing process, doors and glass shown may not match exactly in color to actual product. Masonite reserves the right to make ongoing improvements and changes to existing designs. All left and right files and camber-tops are left and right facing as viewed from the outside.



All sealed units are made with tempered safety glass and comply with the following:

ANSI Z97.1-1984
16 CFR 1201 II
CAN/CGSB-12.1M90



BELLEVILLE® SMOOTH with Alston® glass - door BLS-404-338-2

														
	106-1	106-1P	106-2	106-3	107-1	107-1P	107-2	107-3	122-X	137-3	137-4	137-6	304-2	304-3
AB	106-338-1	106-338-1P	106-338-2	106-338-3	107-338-1	107-338-1P	107-338-2	107-338-3	122-338-X	137-338-3	137-338-4	137-338-6	304-338-2	304-338-3
BMT		•	•			•			•				•	
BLT	•		•	•			•	•	•	•	•	•		•
BFT			•						•				•	
BLS	•	•	•	•	•	•	•	•	•	•	•	•	•	•
OAK			•				•		•		•			•
SHD		•	•		•	•	•		•		•			•
MHD	•	•	•		•	•	•		•		•			•

							n.8.8						
	404-1	404-2	129-1	151-X	152-X	450-1		122-1	122-2	404-1	404-1P	404-2	151-1
AB	404-338-1	404-338-2	129-338-1	151-338-X	152-338-X	450-338-1	122-338-1	122-338-2	404-338-1	404-338-1P	404-338-2	151-338-1	450-338-1
BMT	•		•		•	•	•				•	•	•
BLT		•	•		•	•			•		•	•	•
BFT	•		•	•		•					•	•	•
BLS	•	•	•		•	•	•		•	•	•	•	•
OAK	•	•	•		•	•			•		•	•	•
SHD	•	•	•		•	•		•		•	•	•	•
MHD	•	•	•		•	•		•		•	•	•	•



BMT
Belleville® Mahogany Textured

BLT
Belleville® Oak Textured

BFT
Belleville® Fir Textured

BLS
Belleville® Smooth

OAK
Oakcraft®

SHD
Sta-Tru® HD Steel

MHD
Masonite® HD Steel



T-338 transom

Door images shown in white are available in a variety of textures and materials as noted by the legend.

6'8"



106-338-1 2236



106-338-1P 2236



106-338-2 2236



106-338-3 2236



107-338-1 2237
camber-top



107-338-1P 2237
camber-top



107-338-2 2237
camber-top



107-338-3 2237
camber-top



122-338-X 2264



137-338-3 2210
camber-top



137-338-4 2210
camber-top



137-338-6 2210
camber-top



304-338-2 1640
oval



304-338-3 1640
oval



404-338-1 2248



404-338-2 2248



129-338-1 836

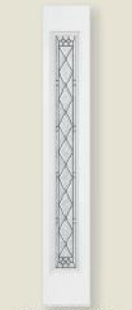

152-338-X 764



450-338-1 848



The Alston family features tempered surf glass. This unique art glass further enhances the privacy and elegance of this series.

clear beveled glass

granite glass

antique black caming

tempered surf glass (inside facing)



LEAST OBSCURE 1 2 3 4 5 6 7 8 9 MOST OBSCURE

7
PRIVACY RATING

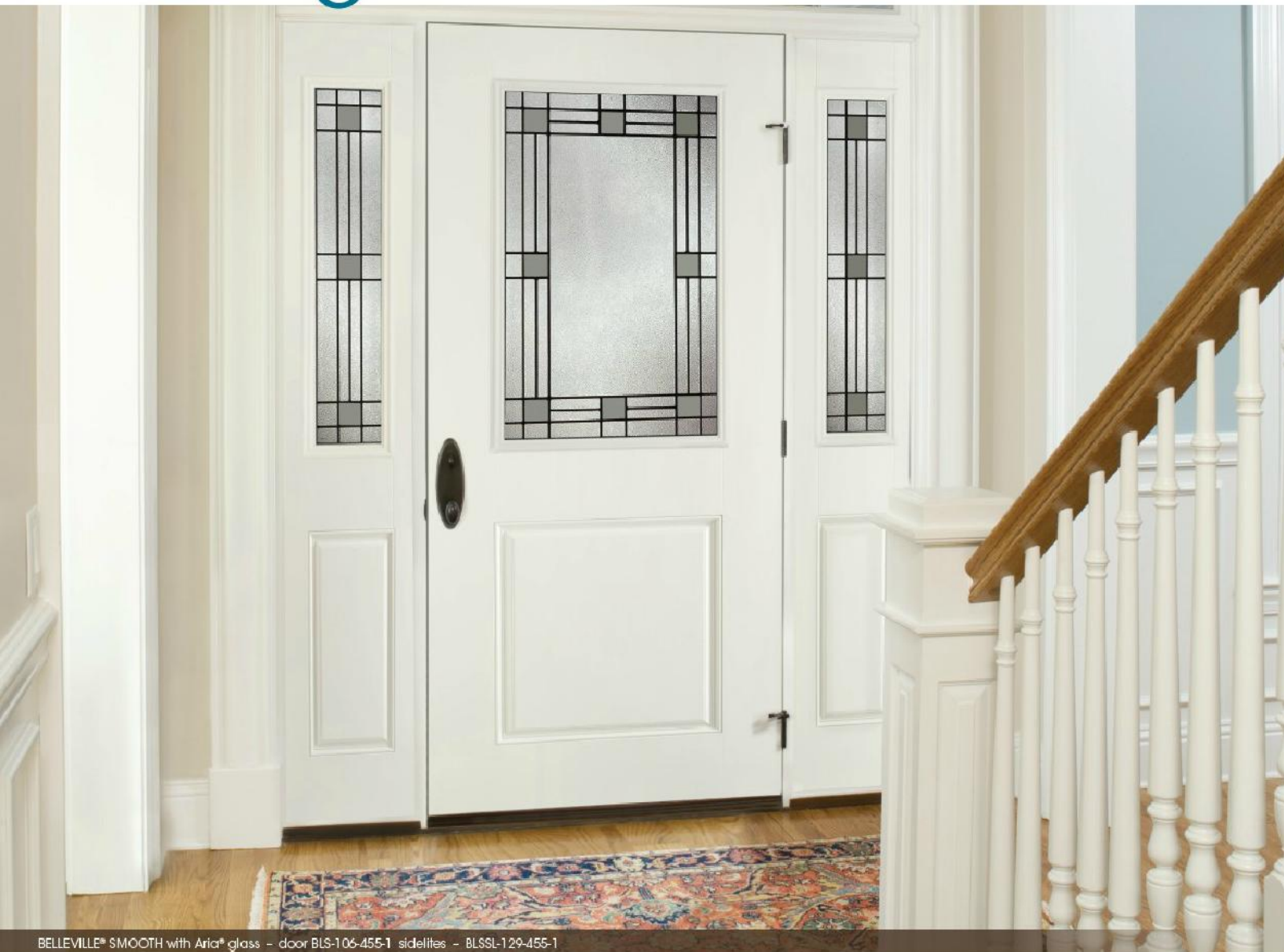

BELLEVILLE® SMOOTH with Aria® glass - door BLS-106-455-1 sidelites - BLSL-129-455-1

	"8.9"										"0.8"					
	106-1	106-1P	106-2	106-3	122-X	404-1	404-2	129-1	152-X	450-1	122-1	122-2	404-1	404-1P	404-2	450-1
SW	106-455-1	106-455-1P	106-455-2	106-455-3	122-455-X	404-455-1	404-455-2	129-455-1	152-455-X	450-455-1	122-455-1	122-455-2	404-455-1	404-455-1P	404-455-2	450-455-1
BMT		•	•		•	•		•	•	•	•				•	•
BLT	•		•	•	•		•	•	•	•			•		•	•
BFT			•	•	•	•		•	•	•						
BLS	•	•	•	•	•	•	•	•	•	•	•		•	•	•	•
OAK			•	•	•	•	•	•	•	•				•	•	•
SHD		•	•	•	•	•	•	•	•	•		•			•	•
MHD	•	•	•	•	•	•	•	•	•	•	•	•			•	•

BMT
Belleville® Mahogany
Textured

BLT
Belleville® Oak Textured

BFT
Belleville® Fir Textured

BLS
Belleville® Smooth

OAK
Oakcraft®

SHD
Sta-Tru® HD Steel

MHD
Masonite® HD Steel

Door images shown in white are available in a variety of textures and materials as noted by the legend.

6'8"



106-455-1 2236



106-455-1P 2236



106-455-2 2236



106-455-3 2236



122-455-X 2264



404-455-1 2248



404-455-2 2248



129-455-1 836



152-455-X 764



450-455-1 848



Featuring SpectraWeld® technology, a unique system utilizing revolutionary composite material that bonds to the glass and simulates caming.

Aria features a full panel double pane of textured glass which provides a high level of obscurity and diffuses the appearance of the SpectraWeld from the inside of the home.

charcoal SpectraWeld®

grey tinted glass

tempered ocean glass (inside facing)

LEAST OBSCURE 1 2 3 4 5 6 7 8 9 MOST OBSCURE

8 PRIVACY RATING

AURORA™ glass

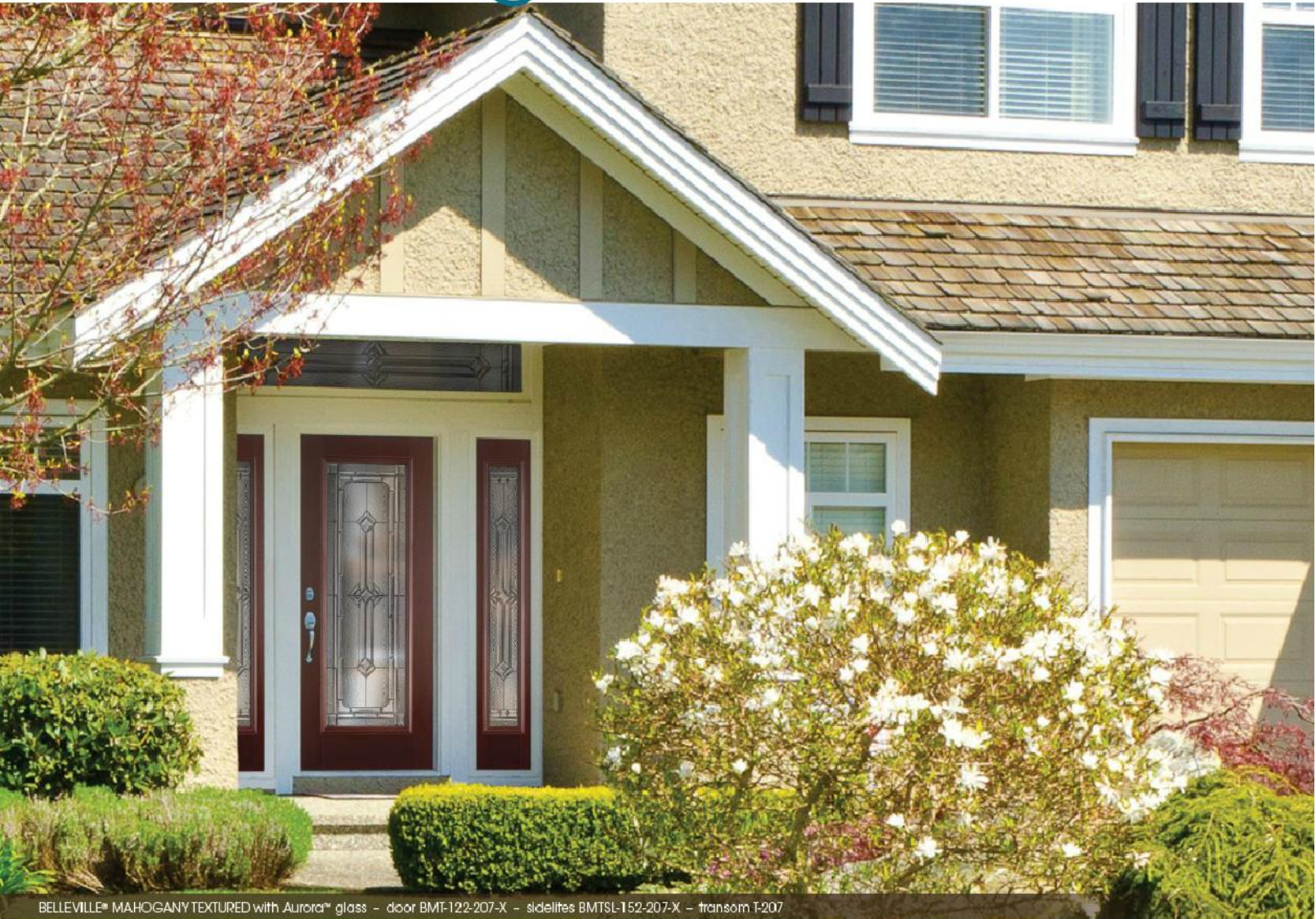

BELLEVILLE® MAHOGANY TEXTURED with Aurora® glass - door BMT-122-207-X - sidelites BMTSL-152-207-X - transom T-207

	-8.9														-0.8								
	106-1	106-1P	106-2	106-3	122-X	203-7	300-X	304-2	304-3	404-1	404-2	129-1	151-X	152-X	450-1	122-1	122-2	404-1	404-1P	404-2	151-1	450-1	
P	106-207-1	106-207-1P	106-207-2	106-207-3	122-207-X	203-207-7	300-207-X	304-207-2	304-207-3	404-207-1	404-207-2	129-207-1	151-207-X	152-207-X	450-207-1	122-207-1	122-207-2	404-207-1	404-207-1P	404-207-2	151-207-1	450-207-1	
BMT		•	•		•	•		•		•				•	•				•	•	•		
BLT	•		•	•	•	•			•		•							•		•	•	•	
BFT			•		•				•			•	•		•						•	•	•
BLS	•	•	•	•	•	•	•	•	•	•	•			•	•			•		•	•	•	•
OAK			•		•		•		•		•			•	•			•		•	•	•	•
SHD		•	•		•	•	•		•		•			•	•			•		•	•	•	•
MHD	•	•	•		•	•	•		•		•			•	•			•		•	•	•	•

BMT
Belleville® Mahogany Textured

BLT
Belleville® Oak Textured

BFT
Belleville® Fir Textured

BLS
Belleville® Smooth

OAK
Oakcraft®

SHD
Sta-Tru® HD Steel

MHD
Masonite® HD Steel



T-207 transom

Door images shown in white are available in a variety of textures and materials as noted by the legend.

6'8"



106-207-1 2236



106-207-1P 2236



106-207-2 2236



106-207-3 2236



122-207-X 2264



203-207-7 842
round-top



300-207-X 2057
oval



304-207-2 1640
oval



304-207-3 1640
oval



404-207-1 2248



404-207-2 2248



129-207-1 836



152-207-X 764



450-207-1 848

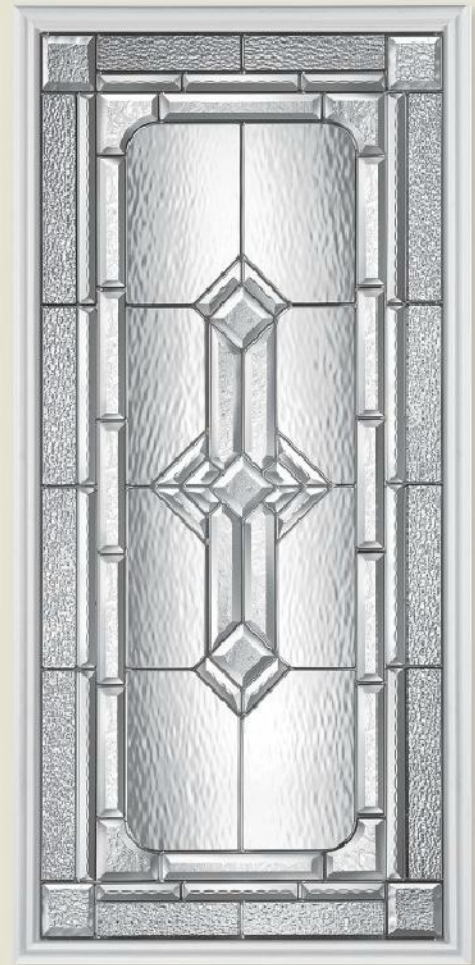

glue chip
beveled glass
platinum caming
granite glass
aqua glass
zipper bevel glass

LEAST OBSCURE 1 2 3 4 5 6 7 8 9 MOST OBSCURE

7
PRIVACY RATING

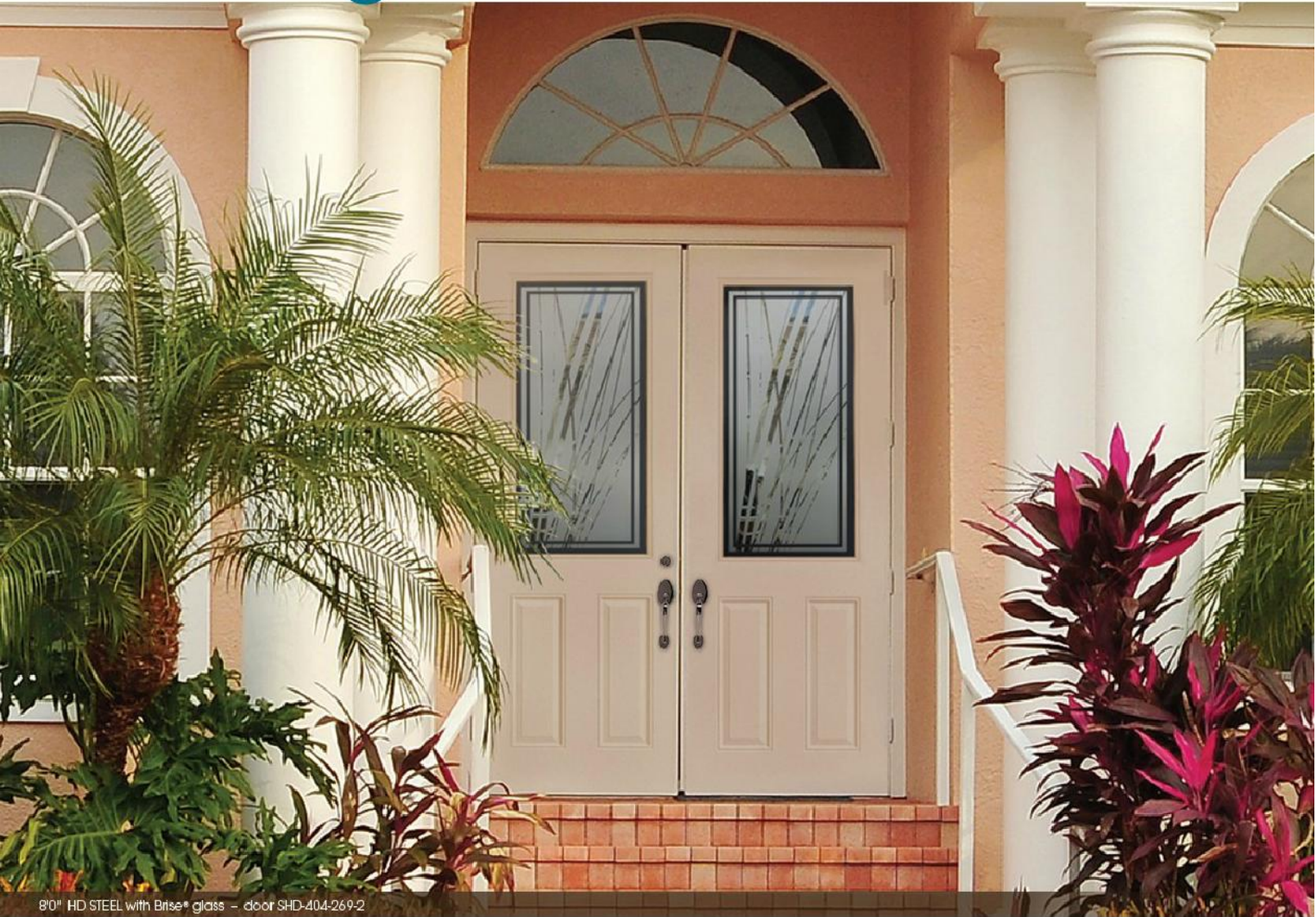

8'0" HD STEEL with Brise® glass - door SHD-404-269-2

	"8,9"										"0,8"			
	106-1	106-1P	106-2	106-3	304-2	304-3	404-1	404-2	129-1	450-1	404-1	404-1P	404-2	450-1
SC	106-269-1	106-269-1P	106-269-2	106-269-3	304-269-2	304-269-3	404-269-1	404-269-2	129-269-1	450-269-1	404-269-1	404-269-1P	404-269-2	450-269-1
BMT		•	•		•		•		•	•			•	•
BLT	•		•	•		•		•	•	•	•		•	•
BFT			•		•		•		•	•			•	•
BLS	•	•	•	•	•	•	•	•	•	•	•	•	•	•
OAK			•		•		•		•	•			•	•
SHD		•	•		•		•		•	•			•	•
MHD	•	•	•		•		•		•	•			•	•

BMT
Belleville® Mahogany
Textured

BLT
Belleville® Oak Textured

BFT
Belleville® Fir Textured

BLS
Belleville® Smooth

OAK
Oakcraft®

SHD
Sta-Tru® HD Steel

MHD
Masonite® HD Steel

Door images shown in white are available in a variety of textures and materials as noted by the legend.

6'8"



106-269-1 2236



106-269-1P 2236



106-269-2 2236



106-269-3 2236

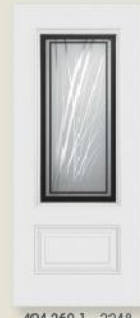

404-269-1 2248



404-269-2 2248



304-269-2 1640
oval



304-269-3 1640
oval



129-269-1 836



450-269-1 848



Brise is an opaque, silkscreen design with fluid lines that create an elegant look.

Brise features an energy saving Low-E coating and argon gas fill.

- charcoal etch
- clear glass
- white etch

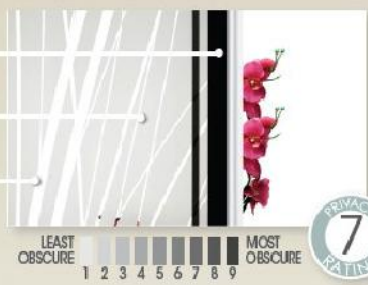

CHORD glass



BELLEVILLE® CRAFTSMAN OAK with Chord glass and applied dentil shelf - door BLT215-115-2

	n0,9														n0,8								
	106-1	106-1P	106-2	106-3	122-X	215-2	228-3	228-4	228-6	404-1	404-2	129-1	151-X	152-X	450-1	615-1	122-1	122-2	404-1	404-1P	404-2	151-1	450-1
AB	106-115-1	106-115-1P	106-115-2	106-115-3	122-115-X	215-115-2	228-115-3	228-115-4	228-115-6	404-115-1	404-115-2	129-115-1	151-115-X	152-115-X	450-115-1	615-115-1	122-115-1	122-115-2	404-115-1	404-115-1P	404-115-2	151-115-1	450-115-1
BMT		•	•		•			•				•		•			•				•	•	•
BLT	•		•	•	•	•	•	•	•		•	•		•	•				•			•	•
BFT			•		•								•		•								
BLS	•	•	•	•	•	•	•	•	•	•	•	•		•	•		•		•	•	•	•	•
OAK			•		•			•			•	•		•	•							•	•
SHD		•	•		•	•		•		•	•	•		•	•			•				•	•
MHD	•	•	•		•	•		•		•	•	•		•	•			•				•	•

BMT
Belleville® Mahogany
Textured

BLT
Belleville® Oak Textured

BFT
Belleville® Fir Textured

BLS
Belleville® Smooth

OAK
Oakcraft®

SHD
Sta-Tru® HD Steel

MHD
Masonite® HD Steel

Door images shown in white are available in a variety of textures and materials as noted by the legend.

6'8"



106-115-1 2236



106-115-1P 2236



106-115-2 2236



106-115-3 2236



122-115-X 2264



215-115-2 2216
shown with optional
dentill shelf



228-115-3 2210



228-115-4 2210



228-115-6 2210



404-115-1 2248



404-115-2 2248



129-115-1 836



152-115-X 764



450-115-1 848



615-115-1 816



An organic linear-styled glass that obscures the view while allowing natural light to flow into the home.

Chord features an energy saving Low-E coating and argon gas fill.



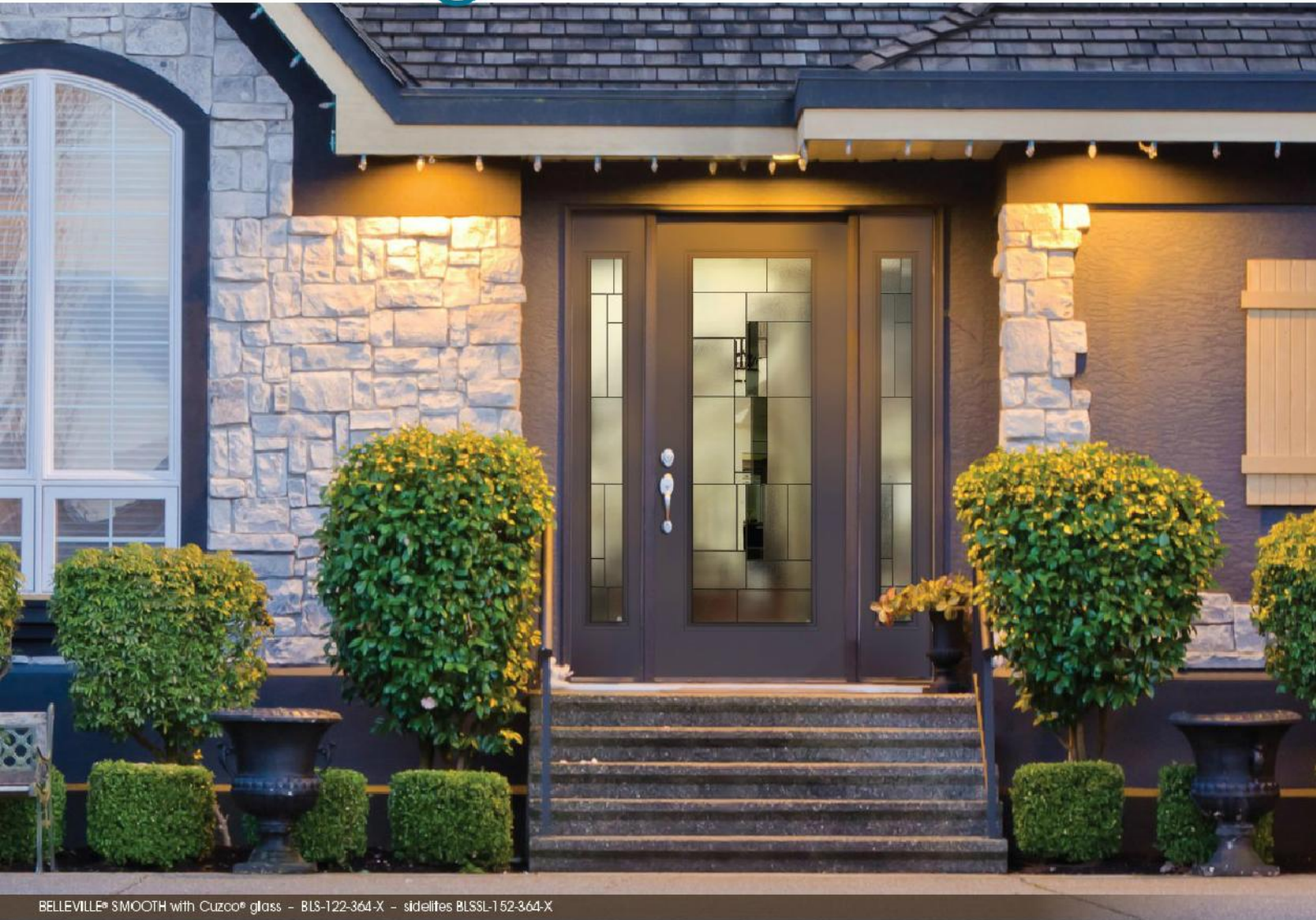

BELLEVILLE® SMOOTH with Cuzco® glass - BLS-122-364-X - sidelites BLSL-152-364-X

	"8.9													"0.8							
	106-1	106-1P	106-2	106-3	122-X	228-3	228-4	228-6	404-1	404-2	129-1	151-X	152-X	450-1	122-1	122-2	404-1	404-1P	404-2	151-1	450-1
AB	106-364-1	106-364-1P	106-364-2	106-364-3	122-364-X	228-364-3	228-364-4	228-364-6	404-364-1	404-364-2	129-364-1	151-364-X	152-364-X	450-364-1	122-364-1	122-364-2	404-364-1	404-364-1P	404-364-2	151-338-1	450-364-1
BMT		•	•		•		•		•		•		•		•		•		•	•	•
BLT	•		•	•	•	•	•	•		•			•	•			•		•	•	•
BFT			•		•		•		•		•		•								
BLS	•	•	•	•	•	•	•	•	•				•	•			•	•	•	•	•
OAK			•				•		•				•						•		•
SHD		•	•		•		•		•				•				•		•	•	•
MHD	•	•	•		•		•		•		•		•		•		•		•	•	•

BMT
Belleville® Mahogany Textured

BLT
Belleville® Oak Textured

BFT
Belleville® Fir Textured

BLS
Belleville® Smooth

OAK
Oakcraft®

SHD
Sta-Tru® HD Steel

MHD
Masonite® HD Steel

Door images shown in white are available in a variety of textures and materials as noted by the legend.

6'8"



106-364-1 2236



106-364-1P 2236



106-364-2 2236



106-364-3 2236



122-364-X 2264



228-364-3 2210



228-364-4 2210



228-364-6 2210



404-364-1 2248



404-364-2 2248



129-364-1 836



152-364-X 764



450-364-1 848



Modern lines and subtle textural layering give Cuzco a fresh take on decorative glass design.

Cuzco features an energy saving Low-E coating and argon gas fill.

dark gray beveled glass

seed glass

antique black caming

pear glass

dark gray glass

mistlife glass

clear beveled glass

LEAST OBSCURE 1 2 3 4 5 6 7 8 9 MOST OBSCURE

8 PRIVACY RATING

ELEMENT[®] glass

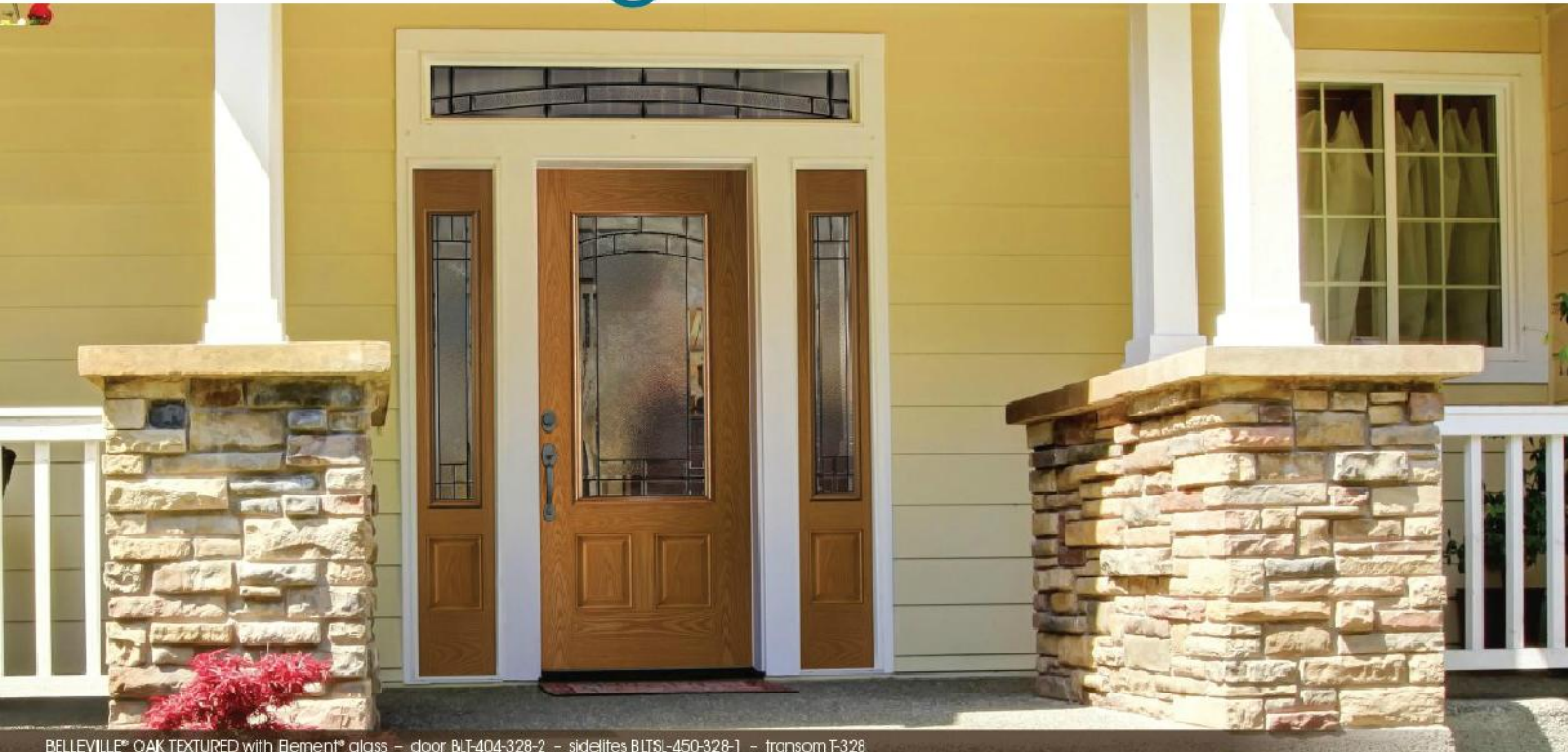

BELLEVILLE[®] OAK TEXTURED with Bement[®] glass – door BLT-404-328-2 – sidelites BLTSL-450-328-1 – transom T-328

	106-1	106-1P	106-2	106-3	107-1	107-1P	107-2	107-3	122-X	137-3	137-4	137-6	215-2	217-2	404-1	404-2
AB	106-328-1	106-328-1P	106-328-2	106-328-3	107-328-1	107-328-1P	107-328-2	107-328-3	122-328-X	137-328-3	137-328-4	137-328-6	215-328-2	217-328-2	404-328-1	404-328-2
BMT		•	•			•			•						•	
BLT	•		•	•			•	•	•	•	•	•	•			•
BFT									•				•		•	
BLS	•	•	•	•	•		•	•	•	•	•	•	•	•	•	•
OAK			•				•		•		•				•	•
SHD		•	•		•	•	•	•	•	•	•	•	•	•	•	•
MHD	•	•	•		•	•	•	•	•	•	•	•	•	•	•	•

	129-1	151-X	152-X	450-1	615-1	122-1	122-2	404-1	404-1P	404-2	151-1	450-1
AB	129-328-1	151-328-X	152-328-X	450-328-1	615-328-1	122-328-1	122-328-2	404-328-1	404-328-1P	404-328-2	151-328-1	450-328-1
BMT	•		•	•		•				•	•	•
BLT	•		•	•	•			•		•	•	•
BFT	•	•		•	•							
BLS	•		•	•	•	•		•	•	•	•	•
OAK	•		•	•						•	•	•
SHD	•		•	•	•		•			•	•	•
MHD	•		•	•	•		•			•	•	•





S-328 transom

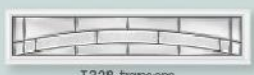

T-328 transom

Door images shown in white are available in a variety of textures and materials as noted by the legend.

6'8"



106-328-1 2236



106-328-1P 2236



106-328-2 2236



106-328-3 2236



107-328-1 2237
camber-top



107-328-1P 2237
camber-top



107-328-2 2237
camber-top



107-328-3 2237
camber-top



122-328-X 2264



137-328-3 2210
camber-top



137-328-4 2210
camber-top



137-328-6 2210
camber-top



215-328-2 2216
shown with optional
dentil shelf



Q1 **new**
217-328-2 2217



404-328-1 2248



404-328-2 2248



129-328-1 836



152-328-X 764



450-328-1 848



615-328-1 816



Q1 Available Q1 2014

*Profile for 217 lite frame is unique. Please specify 77DDP152-03280K-SQS full sidelites to match.

granite
beveled glass
clear
beveled glass
granite glass
antique black
caming

LEAST
OBSCURE 1 2 3 4 5 6 7 8 9 MOST
OBSCURE

6
PRIVACY
RATING

Element® glass
coming AB = antique black 328

GEORGIAN® glass



HD STEEL with Georgian® glass – door SHD-300-517-X – sidelites SHDSL-152-517-X

	106-1	106-1P	106-2	106-3	107-1	107-1P	107-2	107-3	122-X	136-8	300-X	304-2	304-3	306-1	404-1	404-2
B	106-515-1	106-515-1P	106-515-2	106-515-3	107-515-1	107-515-1P	107-515-2	107-515-3	122-515-X	136-515-8	300-515-X	304-515-2	304-515-3	306-515-1	404-515-1	404-515-2
P	106-517-1	106-517-1P	106-517-2	106-517-3	107-517-1	107-517-1P	107-517-2	107-517-3	122-517-X	136-517-8	300-517-X	304-517-2	304-517-3	306-517-1	404-517-1	404-517-2
AB	106-518-1	106-518-1P	106-518-2	106-518-3												
BMT			•													
BLT	•			•												
BFT																
BLS	•	•	•	•	•	•	•	•	•	•	•	•	•	•	•	•
OAK																
SHD		•	•		•	•	•	•	•	•	•			•	•	•
MHD	•	•	•		•	•	•	•	•	•	•			•	•	•

	129-1	151-X	152-X	450-1	122-1	122-2	306-2	404-1	404-1P	404-2	151-1	450-1
B	129-515-1	151-515-X	152-515-X	450-515-1	122-515-1	122-515-2	306-515-2	404-515-1	404-515-1P	404-515-2	151-515-1	450-515-1
P	129-517-1	151-517-X	152-517-X	450-517-1	122-517-1	122-517-2	306-517-2	404-517-1	404-517-1P	404-517-2	151-517-1	450-517-1
AB	129-518-1											
BMT	•			•	•						•	•
BLT	•			•							•	•
BFT	•	•		•							•	•
BLS	•			•	•		•	•	•	•	•	•
OAK	•			•							•	•
SHD	•			•							•	•
MHD	•			•							•	•





C38-645, C38-646, C38-647 transom



C-645, C-646, C-647 transom



S-645, S-646, S-647 transom



E-645, E-646, E-647 transom



T-645, T-646, T-647 transom

Door images shown in white are available in a variety of textures and materials as noted by the legend.

6'8"



106-517-1 2236



106-517-1P 2236



106-517-2 2236



106-517-3 2236



107-517-1 2237
camber-top



107-517-1P 2237
camber-top



107-517-2 2237
camber-top



107-517-3 2237
camber-top



122-517-X 2264



134-517-8 718



300-517-X 2067
oval



304-517-2 1640
oval



304-517-3 1640
oval



306-517-1 1555
oval



404-517-1 2248



404-517-2 2248



129-517-1 836



152-517-X 764



450-517-1 848

Glass shown with platinum
caming. Brass
& antique
black also
available.



glue chip glass

clear beveled glass

platinum caming

LEAST OBSCURE 1 2 3 4 5 6 7 8 9 MOST OBSCURE

7 PRIVACY RATING

GLACE® glass



BELLEVILLE® OAK TEXTURED with Glace® glass - door BLT-106-430-3

	8,9										8,8		
	106-1	106-1P	106-2	106-3	122-X	135-4	135-6	129-1	151-X	152-X	122-1	122-2	151-1
B	106-430-1	106-430-1P	106-430-2	106-430-3	122-430-X	135-430-4	135-430-6	129-430-1	151-430-X	152-430-X	122-430-1	122-430-2	151-430-1
P	106-433-1	106-433-1P	106-433-2	106-433-3	122-433-X	135-433-4	135-433-6	129-433-1	151-433-X	152-433-X	122-433-1	122-433-2	151-433-1
BMT		•	•		•			•		•	•		•
BLT	•		•	•	•	•		•		•			•
BFT			•		•			•	•				
BLS	•	•	•	•	•	•	•			•			•
OAK			•		•	•				•			
SHD		•	•		•	•		•	•		•		•
MHD	•	•	•		•	•		•		•	•		•



BMT
Belleville® Mahogany Textured



BLT
Belleville® Oak Textured



BFT
Belleville® Fir Textured



BLS
Belleville® Smooth



OAK
Oakcraft®



SHD
Sta-Tru® HD Steel



MHD
Masonite® HD Steel

Door images shown in white are available in a variety of textures and materials as noted by the legend.

6'8"



106-430-1 2236



106-430-1P 2236



106-430-2 2236



106-430-3 2236



122-430-X 2264



135-430-4 2210
fan



135-430-6 2210
fan



129-430-1 836



152-430-X 764



Glass shown with brass caming.
Platinum also available.

brass caming

clear beveled glass

LEAST OBSCURE 1 2 3 4 5 6 7 8 9 MOST OBSCURE

1 PRIVACY RATING

IRON SPRINGS® glass



BELLEVILLE® HOLLISTER® FIR TEXTURED with Iron Springs® glass - door BFT-404-918-1

	"8,9											"0,8								
	106-1	106-1P	106-2	106-3	122-X	404-1	404-2	129-1	151-X	152-X	450-1	122-1	122-2	404-1	404-1P	404-2	810-X	151-1	450-1	852-X
WR	106-918-1	106-918-1P	106-918-2	106-918-3	122-918X	404-918-1	404-918-2	129-918-1	151-918-X	152-918-X	450-918-1	122-918-1	122-918-2	404-918-1	404-918-1P	404-918-2	810-918X	151-918-1	450-918-1	852-918-X
BMT		•	•		•	•	•	•		•	•	•				•	•	•	•	•
BLT	•		•	•	•		•			•				•		•	•	•	•	•
BFT			•		•	•		•	•									•	•	•
BLS	•	•	•	•	•	•	•	•	•	•	•	•	•	•	•	•	•	•	•	•
OAK			•		•	•	•	•	•	•	•	•	•	•	•	•	•	•	•	•
SHD		•	•		•	•	•	•	•	•	•		•			•	•	•	•	•
MHD	•	•	•		•	•	•	•	•	•	•	•	•	•	•	•	•	•	•	•



Door images shown in white are available in a variety of textures and materials as noted by the legend.

6'8"



106-918-1 2236



106-918-1P 2236



106-918-2 2236



106-918-3 2236



122-918-X 2264



404-918-1 2248



404-918-2 2248



129-918-1 836



152-918-X 764



450-918-1 848

8'0"



810-918-X 2280



852-918-X 880



Iron Springs features a full panel of textured glass which provides a high level of obscurity and diffuses the appearance of the wrought iron from the inside of the home.

Iron Springs features an energy saving Low-E coating.

pear glass (inside facing)
clear glass (outside facing)
1/2" square wrought iron

LEAST OBSCURE 1 2 3 4 5 6 7 8 9 MOST OBSCURE

8 PRIVACY RATING

KORDELLA® glass



BELLEVILLE® SMOOTH with Kordella® glass - door BLS-122-686-X - sidelites BLS-152-686-X

	"8.9"												"0.8"								
	106-1	106-1P	106-2	106-3	122-X	228-3	228-4	228-6	404-1	404-2	129-1	151-X	152-X	450-1	122-1	122-2	404-1	404-1P	404-2	151-1	450-1
AB	106-686-1	106-686-1P	106-686-2	106-686-3	122-686-X	228-686-3	228-686-4	228-686-6	404-686-1	404-686-2	129-686-1	151-686-X	152-686-X	450-686-1	122-686-1	122-686-2	404-686-1	404-686-1P	404-686-2	151-686-1	450-686-1
BMT		•	•		•		•		•					•					•	•	•
BLT	•		•	•	•	•	•			•				•			•			•	•
BFT			•		•		•		•		•			•							
BLS	•	•	•	•	•	•	•	•	•	•	•	•	•	•	•		•	•	•	•	•
OAK			•		•		•		•					•					•		•
SHD		•	•		•		•		•		•		•		•				•	•	•
MHD	•	•	•		•		•		•		•		•		•				•	•	•

BMT
Belleville® Mahogany
Textured

BLT
Belleville® Oak Textured

BFT
Belleville® Fir Textured

BLS
Belleville® Smooth

OAK
Oakcraft®

SHD
Sta-Tru® HD Steel

MHD
Masonite® HD Steel

Door images shown in white are available in a variety of textures and materials as noted by the legend.

6'8"



106-686-1 2236



106-686-1P 2236



106-686-2 2236



106-686-3 2236



122-686-X 2264



228-686-3 2210



228-686-4 2210



228-686-6 2210



404-686-1 2248



404-686-2 2248



129-686-1 836



152-686-X 764



450-686-1 848



Kordella's flowing lines and varied glass textures provide simple elegance to any home.

Kordella features an energy saving Low-E coating and argon gas fill.

white etch glass
dark gray glass
pear glass
seed glass
clear beveled glass

LEAST OBSCURE 1 2 3 4 5 6 7 8 9 MOST OBSCURE

8 PRIVACY RATING

MADRID[®] glass



8'0" HD STEEL with Madrid[®] glass - door SHD-810-900-X - sidelites SHDSL-852-900-X - transom T-900

8'9"																			
	106-1	106-1P	106-2	106-3	107-1	107-1P	107-2	107-3	122-X	135-4	135-6	137-3	137-4	137-6	203-7	228-3	228-4	228-6	300-X
AB	106-900-1	106-900-1P	106-900-2	106-900-3	107-900-1	107-900-1P	107-900-2	107-900-3	122-900-X	135-900-4	135-900-6	137-900-3	137-900-4	137-900-6	203-900-7	228-900-3	228-900-4	228-900-6	300-900-X
BMT		•	•			•			•						•				
BLT	•		•	•			•	•		•	•	•	•	•	•	•	•	•	•
BFT			•						•										
BLS	•	•	•	•	•	•	•	•	•	•	•	•	•	•	•	•	•	•	•
OAK			•				•	•	•	•			•				•		•
SHD		•	•		•	•	•	•	•	•			•		•		•		•
MHD	•	•	•		•	•	•	•	•	•			•		•		•		•

8'9"																				
	304-2	304-3	306-1	404-1	404-2	129-1	151-X	152-X	450-1	122-1	122-2	201-7	306-2	404-1	404-1P	404-2	810-X	151-1	450-1	852-X
AB	304-900-2	304-900-3	306-900-1	404-900-1	404-900-2	129-900-1	151-900-X	152-900-X	450-900-1	122-900-1	122-900-2	201-900-7	306-900-2	404-900-1	404-900-1P	404-900-2	810-900-X	151-900-1	450-900-1	852-900-X
BMT	•			•		•		•	•	•			•				•			•
BLT		•	•		•	•		•				•		•			•	•	•	•
BFT	•			•		•	•		•											
BLS	•	•		•	•	•	•	•	•	•		•	•	•	•	•	•	•	•	•
OAK		•			•	•	•	•	•								•		•	•
SHD		•	•	•	•	•	•	•	•			•					•	•	•	•
MHD		•	•	•	•	•	•	•	•			•					•	•	•	•

BMT
Belleville[®] Mahogany Textured

BLT
Belleville[®] Oak Textured

BFT
Belleville[®] Fir Textured

BLS
Belleville[®] Smooth

OAK
Oakcraft[®]

SHD
Sta-Tru[®] HD Steel

MHD
Masonite[®] HD Steel



C-38-900 transom



S-900 transom



E-900 transom



T-900 transom

Door images shown in white are available in a variety of textures and materials as noted by the legend.

6'8"



106-900-1 2236



106-900-1P 2236



106-900-2 2236



106-900-3 2236



107-900-1 2237
camber-top



107-900-1P 2237
camber-top



107-900-2 2237
camber-top



107-900-3 2237
camber-top



122-900-X 2264



135-900-4 2210
fan



135-900-6 2210
fan



137-900-3 2210
camber-top



137-900-4 2210
camber-top



137-900-6 2210
camber-top



203-900-7 842
round-top



228-900-3 2210



228-900-4 2210



228-900-6 2210



300-900-X 2057
oval



304-900-2 1640
oval



304-900-3 1640
oval

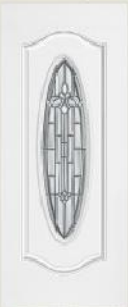

306-900-1 1556
oval



404-900-1 2248



404-900-2 2248



129-900-1 836



152-900-X 764



450-900-1 848

8'0"



201-900-7 858
round-top



810-900-X 2280

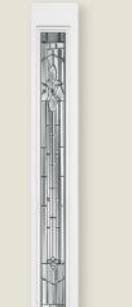

852-900-X 880

grey beveled glass

clear beveled glass

antique black
caming



LEAST
OBSCURE 1 2 3 4 5 6 7 8 9 MOST
OBSCURE



MARQUISE® glass



8'0" BELLEVILLE® OAK TEXTURED with Marquise® glass – BLT810-778-X – sidelites BLTSL-852-778-X

8'0"																		
	106-1	106-1P	106-2	106-3	122-X	135-4	135-6	203-7	300-X	304-2	304-3	306-1	404-1	404-2	129-1	151-X	152-X	450-1
B	106-777-1	106-777-1P	106-777-2	106-777-3	122-777-X	135-777-4	135-777-6	203-777-7	300-777-X	304-777-2	304-777-3	306-777-1	404-777-1	404-777-2	129-777-1	151-777-X	152-777-X	450-777-1
P	106-778-1	106-778-1P	106-778-2	106-778-3	122-778-X	135-778-4	135-778-6	203-778-7	300-778-X	304-778-2	304-778-3	306-778-1	404-778-1	404-778-2	129-778-1	151-778-X	152-778-X	450-778-1
AB	106-779-1	106-779-1P	106-779-2	106-779-3	122-779-X				300-779-X	304-779-2	304-779-3		404-779-1	404-779-2	129-779-1	151-779-X	152-779-X	450-779-1
BMT		•	•		•			•		•			•		•		•	•
BLT	•		•	•	•	•	•	•	•		•	•		•	•		•	•
BFT			•		•					•			•		•	•		•
BLS	•		•	•	•	•	•	•	•		•	•	•	•			•	•
OAK			•		•	•	•	•	•		•	•	•	•			•	•
SHD		•	•		•	•	•	•	•	•	•	•	•	•	•	•	•	•
MHD	•	•	•		•	•	•	•	•	•	•	•	•	•	•	•	•	•

8'0"											
	122-1	122-2	201-7	306-2	404-1	404-1P	404-2	810-X	151-1	450-1	852-X
B	122-777-1	122-777-2	201-777-7	306-777-2	404-777-1	404-777-1P	404-777-2		151-777-1	450-777-1	
P	122-778-1	122-778-2	201-778-7	306-778-2	404-778-1	404-778-1P	404-778-2	810-778-X	151-778-1	450-778-1	852-778-X
AB	122-779-1	122-779-2			404-779-1	404-779-1P	404-779-2			450-779-1	
BMT	•			•			•	•	•	•	•
BLT			•		•		•	•	•	•	•
BFT											
BLS	•		•	•	•	•	•	•	•	•	•
OAK							•	•	•	•	•
SHD		•					•	•	•	•	•
MHD		•					•	•	•	•	•

BMT
Belleville® Mahogany Textured

BLT
Belleville® Oak Textured

BFT
Belleville® Fir Textured

BLS
Belleville® Smooth

OAK
Oakcraft®

SHD
Sta-Tru® HD Steel

MHD
Masonite® HD Steel



C38-645, C38-646, C38-647 transom

C-645, C-646, C-647 transom

S-645, S-646, S-647 transom

E-645, E-646, E-647 transom

T-645, T-646, T-647 transom

A48-777, A48-779 accent window

Door images shown in white are available in a variety of textures and materials as noted by the legend.

6'8"



106-778-1 2236

106-778-1P 2236

106-778-2 2236

106-778-3 2236

122-778-X 2264

135-778-4 2210 fan

135-778-6 2210 fan



203-778-7 842 round-top

300-778-X 2067 oval

304-778-2 1640 oval

304-778-3 1640 oval

306-778-1 1555 oval



404-778-1 2248

404-778-2 2248

129-778-1 836

152-778-X 764

450-778-1 848



8'0"



201-778-7 858 round-top

810-778-X 2280

852-778-X 880

Glass shown with platinum caming. Brass & antique black also available.

granite glass
 clear beveled glass
 glue chip beveled glass
 antique black caming

LEAST OBSCURE 1 2 3 4 5 6 7 8 9 MOST OBSCURE



Marquise® glass
 caming B = brass 777 P = platinum 778 AB = antique black 779

MONDRIAN[®] glass

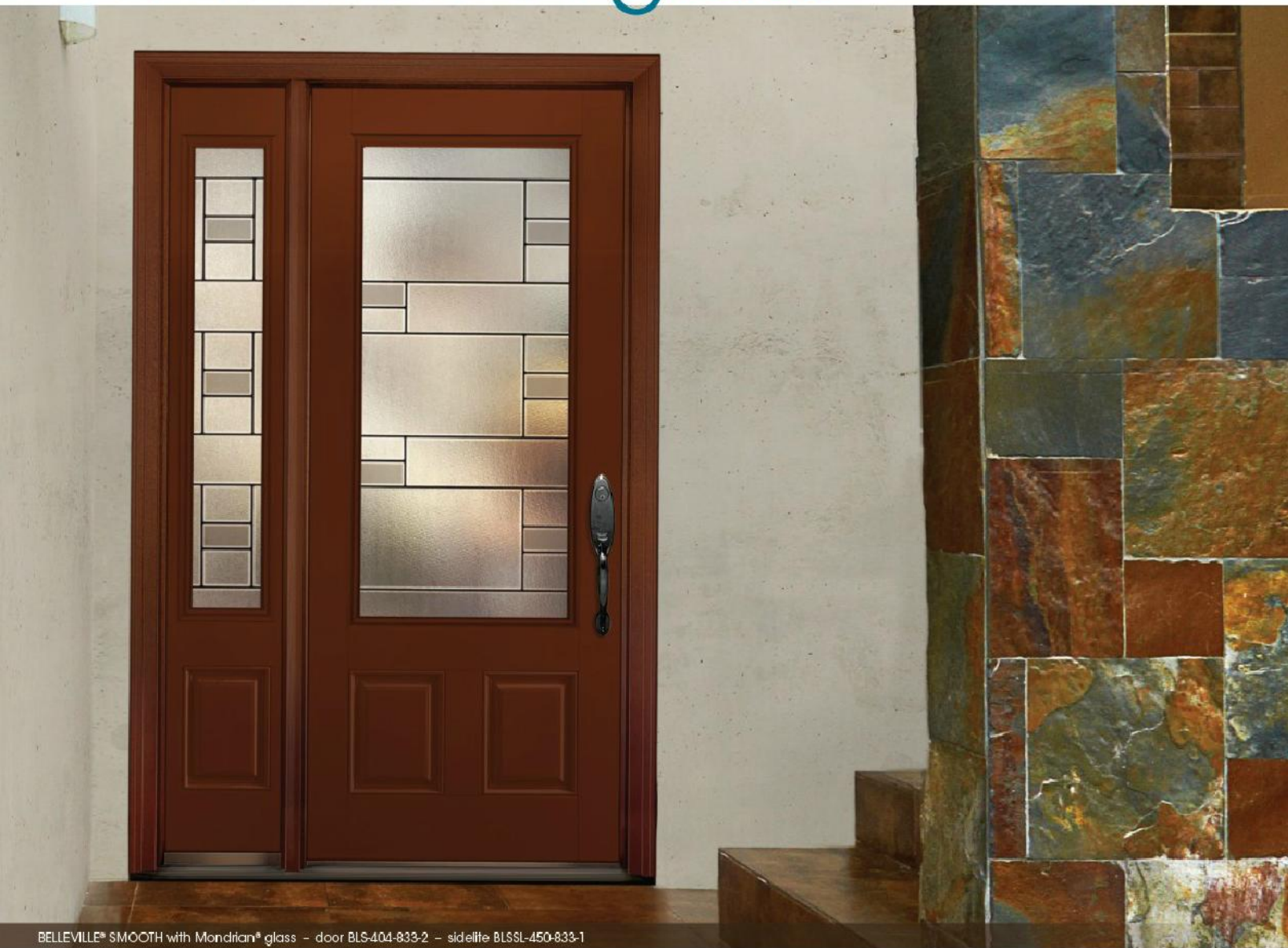

BELLEVILLE[®] SMOOTH with Mondrian[®] glass - door BLS-404-833-2 - side lite BLSL-450-833-1

	"8.9										"0.8					
	106-1	106-1P	106-2	106-3	122-X	404-1	404-2	129-1	152-X	450-1	122-1	122-2	404-1	404-1P	404-2	450-1
SW	106-833-1	106-833-1P	106-833-2	106-833-3	122-833X	404-833-1	404-833-2	129-833-1	152-833-X	450-833-1	122-833-1	122-833-2	404-833-1	404-833-1P	404-833-2	450-833-1
BMT		•	•		•	•		•		•	•				•	•
BLT	•		•	•	•		•	•	•	•					•	•
BFT			•		•	•		•		•						
BLS	•	•	•	•	•	•	•	•	•	•	•		•	•	•	•
OAK			•	•		•	•	•	•	•					•	•
SHD		•	•		•	•	•	•	•	•		•			•	•
MHD	•	•	•		•	•	•	•	•	•		•			•	•

BMT
Belleville[®] Mahogany
Textured

BLT
Belleville[®] Oak Textured

BFT
Belleville[®] Fir Textured

BLS
Belleville[®] Smooth

OAK
Oakcraft[®]

SHD
Sta-Tru[®] HD Steel

MHD
Masonite[®] HD Steel

Door images shown in white are available in a variety of textures and materials as noted by the legend.

6'8"



106-833-1 2236



106-833-1P 2236



106-833-2 2236



106-833-3 2236



122-833-X 2264



404-833-1 2248



404-833-2 2248



129-833-1 836



152-833-X 764



450-833-1 848



Featuring SpectraWeld® technology, a unique system utilizing revolutionary composite material that bonds to the glass and simulates caming.

Mondrian features a full panel double pane of textured glass which provides a high level of obscurity and diffuses the appearance of the SpectraWeld from the inside of the home.

tempered ocean glass (inside facing)
grey ceramic frit
charcoal SpectraWeld®

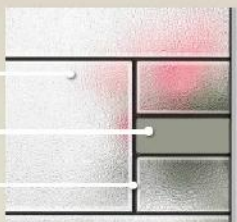

NAPLES[®] glass



8'0" BELLEVILLE[®] OAK TEXTURED with Naples[®] glass - door BLT-404-366-1

	106-1	106-1P	106-2	106-3	122-X	203-7	215-2	217-2	228-3	228-4	228-6	404-1	404-2
AB	106-366-1	106-366-1P	106-366-2	106-366-3	122-366X	203-366-7	215-366-2	217-217-2	228-366-3	228-366-4	228-366-6	404-366-1	404-366-2
BMT		•	•		•	•				•		•	
BLT	•		•	•	•	•	•		•	•	•		•
BFT			•		•	•						•	
BLS	•	•	•	•	•	•	•		•	•	•		•
OAK			•		•				•	•	•		•
SHD		•	•		•	•	•	•	•	•	•	•	•
MHD	•	•	•		•	•	•	•	•	•	•	•	•

	129-1	151-X	152-X	450-1	615-1	122-1	122-2	404-1	404-1P	404-2	810-X	151-1	450-1	852-X
AB	129-366-1	151-366-X	152-366-X	450-366-1	615-366-1	122-366-1	122-366-2	404-366-1	404-366-1P	404-366-2	810-366-X	151-366-1	450-366-1	852-366-X
BMT	•		•	•	•	•				•	•	•	•	•
BLT	•		•	•	•			•		•	•	•	•	•
BFT		•		•	•									
BLS	•		•	•	•	•		•	•	•	•	•	•	•
OAK	•		•	•	•					•	•	•	•	•
SHD	•	•	•	•	•		•			•	•	•	•	•
MHD	•		•	•	•		•			•	•	•	•	•





T-366 transom



A48-366
accent window

Door images shown in white are available in a variety of textures and materials as noted by the legend.

6'8"



106-366-1 2236



106-366-1P 2236



106-366-2 2236



106-366-3 2236

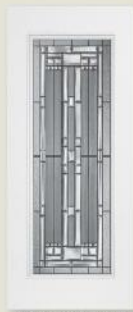

122-366-X 2264



203-366-7 842
round-top



215-366-2 2216
shown with optional
dentill shelf



Q1 **new**
*217-366-2 2217

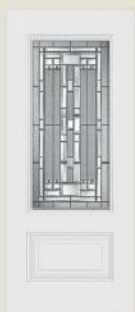

404-366-1 2248



404-366-2 2248



228-366-3 2210



228-366-4 2210



228-366-6 2210



129-366-1 836



152-366-X 764



450-366-1 848



615-366-1 816

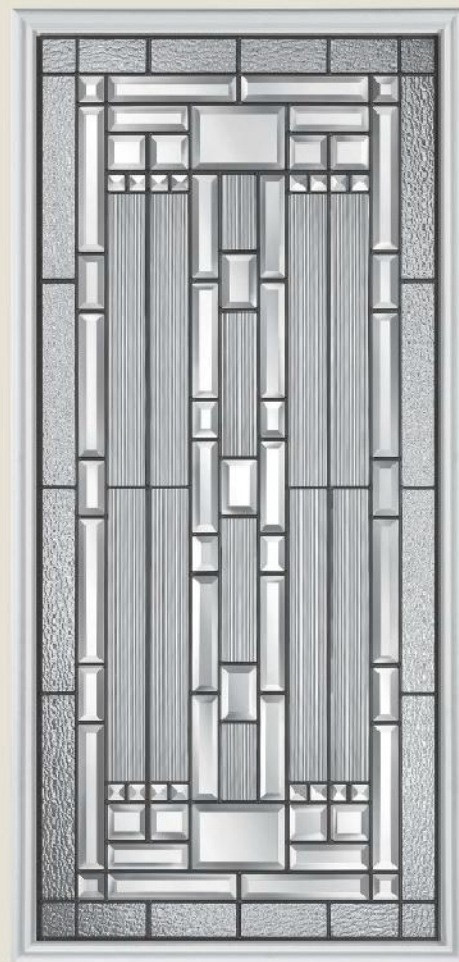

8'0"



810-366-X 2280



852-366-X 880

Q1 Available Q1 2014

*Profile for 217 lite frame is unique. Please specify
77DDP152-03660K-SQS full sidelites to match.

granite glass
clear beveled glass
narrow reed glass
antique black caming

LEAST OBSCURE 1 2 3 4 5 6 7 8 9 MOST OBSCURE

8
REINFORCED
RATING



BELLEVILLE[®] SMOOTH with Panama[®] glass - door BLS-135-725-4

n0.9																		
	106-1	106-1P	106-2	106-3	122-X	135-4	135-6	203-7	300-X	304-2	304-3	306-1	404-1	404-2	129-1	151-X	152-X	450-1
B	106-724-1	106-724-1P	106-724-2	106-724-3	122-724-X	135-724-4	135-724-6	203-724-7	300-724-X	304-724-2	304-724-3	306-724-1	404-724-1	404-724-2	129-724-1	151-724-X	152-724-X	450-724-1
P	106-725-1	106-725-1P	106-725-2	106-725-3	122-725-X	135-725-4	135-725-6	203-725-7	300-725-X	304-725-2	304-725-3	306-725-1	404-725-1	404-725-2	129-725-1	151-725-X	152-725-X	450-725-1
BMT		•	•		•			•		•			•		•		•	•
BLT	•		•	•	•	•	•	•		•		•		•			•	•
BFT											•					•		•
BLS	•	•	•	•	•	•	•	•	•	•	•	•	•	•	•	•	•	•
OAK			•	•	•	•	•	•	•	•	•	•	•	•	•	•	•	•
SHD		•	•	•	•	•	•	•	•	•	•	•	•	•	•	•	•	•
MHD	•	•	•	•	•	•	•	•	•	•	•	•	•	•	•	•	•	•

n0.8											
	122-1	122-2	201-7	306-2	404-1	404-1P	404-2	810-X	151-1	450-1	852-X
B	122-724-1	122-724-2	201-724-7	306-724-2	404-724-1	404-724-1P	404-724-2	810-724-X	151-724-1	450-724-1	852-724-X
P	122-725-1	122-725-2	201-725-7	306-725-2	404-725-1	404-725-1P	404-725-2	810-725-X	151-725-1	450-725-1	852-725-X
BMT	•			•			•	•	•	•	•
BLT			•		•		•	•	•	•	•
BFT											
BLS	•		•	•	•	•	•	•	•	•	•
OAK							•	•	•	•	•
SHD		•					•	•	•	•	•
MHD	•	•					•	•	•	•	•





C38-724, C38-725 transom



C-724, C-725 transom



S-724, S-725 transom



E-724, E-725 transom



T-724, T-725 transom

Door images shown in white are available in a variety of textures and materials as noted by the legend.

6'8"



106-725-1 2236



106-725-1P 2236



106-725-2 2236



106-725-3 2236

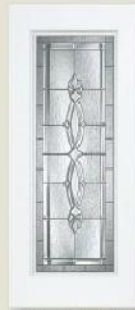

122-725-X 2264



135-725-4 2210 fan



135-725-6 2210 fan



203-725-7 842 round-top



300-725-X 2057 oval



304-725-2 1640 oval



304-725-3 1640 oval



306-725-1 1555 oval



404-725-1 2248



404-725-2 2248



129-725-1 836



152-725-X 764



450-725-1 848



8'0"



201-725-7 858 round-top



810-725-X 2280



852-725-X 880

Glass shown with platinum caming. Brass also available.

- granite glass
- clear beveled glass
- platinum caming
- aqua glass



LEAST OBSCURE 1 2 3 4 5 6 7 8 9 MOST OBSCURE



Panama® glass
caming B = brass 724 P = platinum 725



PEAR glass

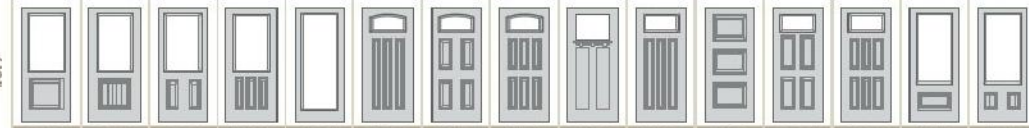

BELLEVILLE® CRAFTSMAN OAK with Pear glass and applied dentil shelf - BLT-215-116-2

															
	106-1	106-1P	106-2	106-3	122-X	137-3	137-4	137-6	215-2	228-3	217-2	228-4	228-6	404-1	404-2
AB	106-116-1	106-116-1P	106-116-2	106-116-3	122-116X	137-116-3	137-116-4	137-116-6	215-116-2	228-116-3	217-116-2	228-116-4	228-116-6	404-116-1	404-116-2
BMT		•	•		•									•	•
BLT	•		•	•	•	•	•	•	•	•			•		•
BFT			•		•				•					•	
BLS	•	•	•	•		•	•	•	•	•			•	•	•
OAK			•		•		•						•		•
SHD		•	•		•		•		•				•	•	•
MHD	•	•	•		•		•		•				•	•	•

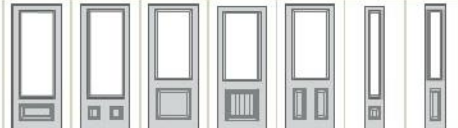
												
	129-1	151-X	152-X	450-1	615-1	122-1	122-2	404-1	404-1P	404-2	151-1	450-1
AB	129-116-1	151-116X	152-116X	450-116-1	615-116-1	122-116-1	122-116-2	404-116-1	404-116-1P	404-116-2	151-116-1	450-116-1
BMT	•		•	•		•				•	•	•
BLT	•		•	•	•			•		•	•	
BFT	•	•		•	•							
BLS	•		•	•	•	•		•	•	•	•	•
OAK	•		•	•						•		•
SHD	•		•	•	•		•			•	•	•
MHD	•		•	•	•		•			•	•	•

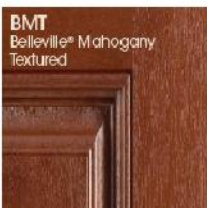

BMT
Belleville® Mahogany Textured

BLT
Belleville® Oak Textured

BFT
Belleville® Fir Textured

BLS
Belleville® Smooth

OAK
Oakcraft®

SHD
Sta-Tru® HD Steel

MHD
Masonite® HD Steel

Door images shown in white are available in a variety of textures and materials as noted by the legend.

6'8"



106-116-1 2236



106-116-1P 2236



106-116-2 2236



106-116-3 2236



122-116-X 2264



137-116-3 2210
camber-top



137-116-4 2210
camber-top



137-116-6 2210
camber-top



215-116-2 2216
shown with optional
dentil shelf



Q1 **new**
217-366-2 2217



228-116-3 2210



228-116-4 2210



A classic textured glass with assuring privacy bringing the ambiance of natural light indoors.

Pearl features an energy saving Low-E coating and argon gas fill.



228-116-6 2210



404-116-1 2248



404-116-2 2248



129-116-1 836



152-116-X 764



450-116-1 848



615-116-1 816

Q1 Available Q1 2014

*Profile for 217 lite frame is unique. Please specify 77DDP152-01160K-SQS full sidelites to match.

Your Glass Your SDL Kit



LEAST OBSCURE 1 2 3 4 5 6 7 8 9 MOST OBSCURE

9
PRIVACY RATING

QUATTRO® glass



BELLEVILLE® HOLLISTER® SMOOTH with Quattro® glass - door BLS-404-957-1 - sidelites BLSL-450-957-1

	48.9										40.8							
WR	106-957-1	106-957-1P	106-957-2	106-957-3	122-957-X	404-957-1	404-957-2	129-957-1	151-957-X	152-957-X	450-957-1	122-957-1	122-957-2	404-957-1	404-957-1P	404-957-2	151-957-1	450-957-1
BMT		•	•		•	•		•		•	•	•				•	•	•
BLT	•		•	•	•		•	•		•	•			•		•	•	•
BFT			•		•	•		•	•		•							
BLS	•	•	•	•	•	•		•		•	•	•		•		•	•	•
OAK			•		•	•		•		•	•					•	•	•
SHD		•	•		•	•		•		•	•		•			•	•	•
MHD	•	•	•		•	•		•		•	•		•			•	•	•

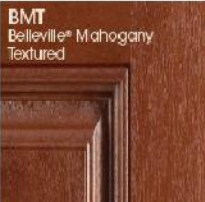

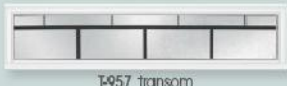

T-957 transom

Door images shown in white are available in a variety of textures and materials as noted by the legend.

6'8"



106-957-1 2236



106-957-1P 2236



106-957-2 2236



106-957-3 2236



122-957-X 2264



404-957-1 2248



404-957-2 2248



129-957-1 836



152-957-X 764



450-957-1 848

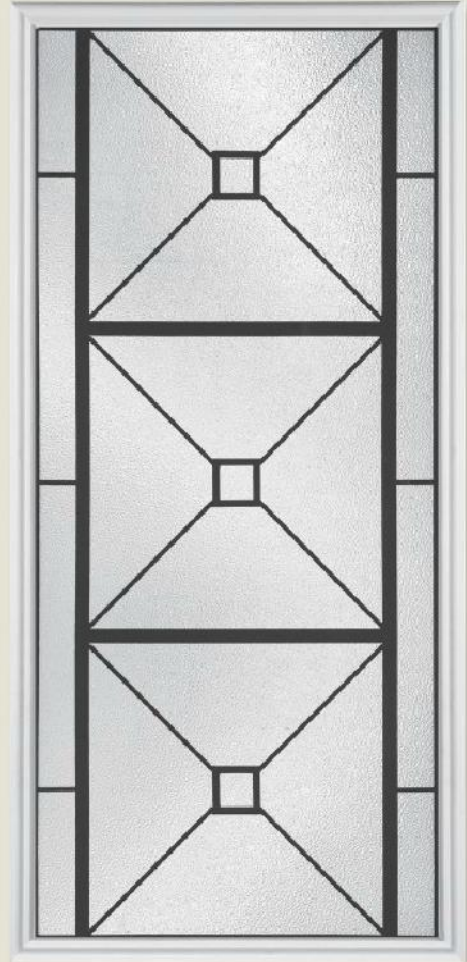

Quattro features a full panel of textured glass which provides a high level of obscurity and diffuses the appearance of the wrought iron from the inside of the home.

tempered oceanic glass (inside facing)

wrought iron

LEAST OBSCURE 1 2 3 4 5 6 7 8 9 MOST OBSCURE

8 PRIVACY RATING

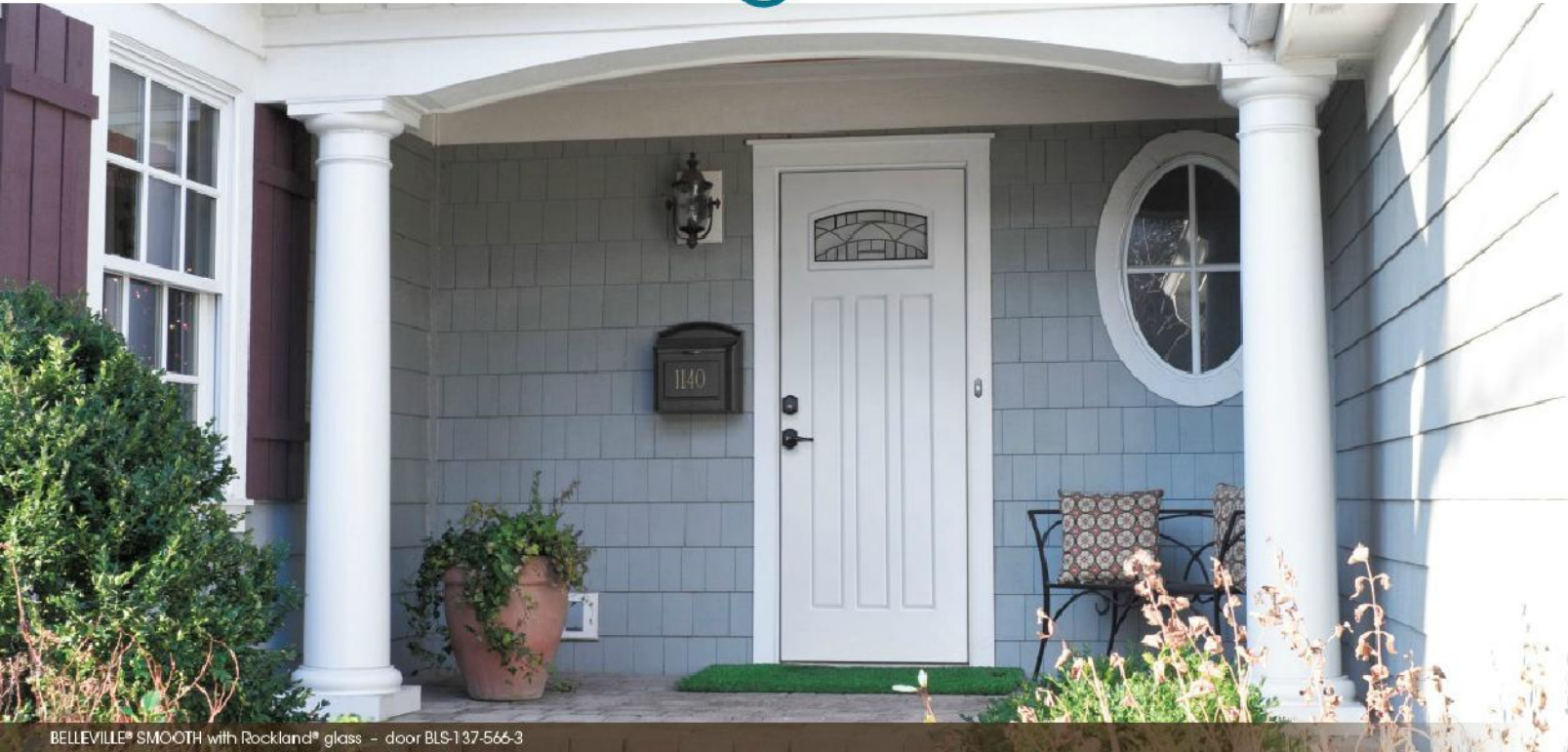

BELLEVILLE® SMOOTH with Rockland® glass - door BLS-1 137-566-3

														
	106-1	106-1P	106-2	106-3	107-1	107-1P	107-2	107-3	122-X	137-3	137-4	137-6	404-1	404-2
AB	106-566-1	106-566-1P	106-566-2	106-566-3	107-566-1	107-566-1P	107-566-2	107-566-3	122-566-X	137-566-3	137-566-4	137-566-6	404-566-1	404-566-2
BMT		•	•			•			•				•	
BLT	•		•	•			•	•		•	•	•		•
BFT			•						•				•	
BLS	•	•	•	•	•	•	•	•	•	•	•	•	•	•
OAK			•				•	•	•	•	•	•	•	•
SHD		•	•		•	•	•	•	•	•	•	•	•	•
MHD	•	•	•		•	•	•	•	•	•	•	•	•	•

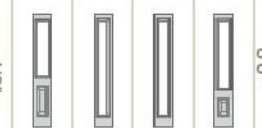
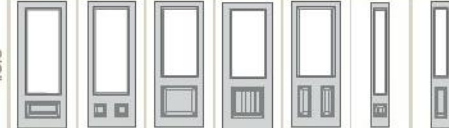
											
	129-1	151-X	152-X	450-1	122-1	122-2	404-1	404-1P	404-2	151-1	450-1
AB	129-566-1	151-566-X	152-566-X	450-566-1	122-566-1	122-566-2	404-566-1	404-566-1P	404-566-2	151-566-1	450-566-1
BMT	•		•	•	•				•	•	•
BLT	•		•	•			•		•	•	
BFT		•		•						•	
BLS	•		•	•	•		•		•	•	•
OAK	•		•	•					•	•	•
SHD	•		•	•		•			•	•	•
MHD	•		•	•		•			•	•	•

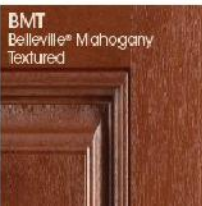

Door images shown in white are available in a variety of textures and materials as noted by the legend.

6'8"



106-566-1 2236



106-566-1P 2236



106-566-2 2236



106-566-3 2236



107-566-1 2237
cambertop



107-566-1P 2237
cambertop



107-566-2 2237
cambertop



107-566-3 2237
cambertop

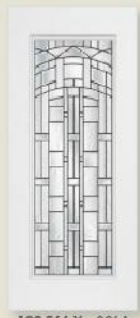

122-566-X 2264



137-566-3 2210
cambertop



137-566-4 2210
cambertop



137-566-6 2210
cambertop



404-566-1 2248



404-566-2 2248



129-566-1 836



152-566-X 764



450-566-1 848

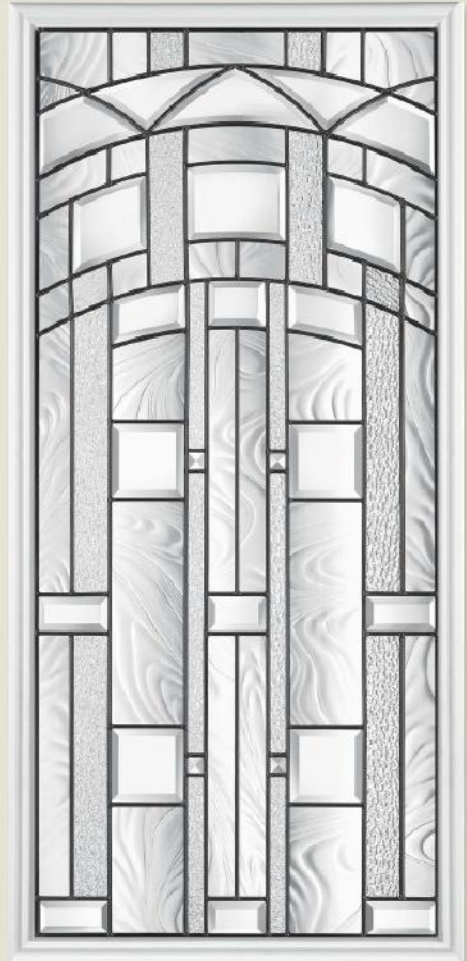

- antique black caming
- granite glass
- clear beveled glass
- clear swirl glass



SIENNA[®] glass



BELLEVILLE[®] SMOOTH with Sienna[®] glass - door BLS-404-817-2

	106-1	106-1P	106-2	106-3	107-1	107-1P	107-2	107-3	122-X	304-2	304-3	404-1	404-2
WR	106-817-1	106-817-1P	106-817-2	106-817-3	107-817-1	107-817-1P	107-817-2	107-817-3	122-817-X	304-817-2	304-817-3	404-817-1	404-817-2
BMT		•	•			•			•	•		•	
BLT	•		•	•			•	•	•		•		•
BFT			•						•	•		•	
BLS	•	•	•	•	•	•	•	•	•	•	•	•	•
OAK			•				•		•		•		•
SHD		•	•		•	•			•		•	•	•
MHD	•	•	•		•	•	•	•	•		•	•	•

	129-1	151-X	152-X	450-1	122-1	122-2	404-1	404-1P	404-2	151-1	450-1
WR	129-817-1	151-817-X	152-817-X	450-817-1	122-817-1	122-817-2	404-817-1	404-817-1P	404-817-2	151-817-1	450-817-1
BMT	•		•	•	•				•	•	•
BLT	•		•	•					•	•	•
BFT		•		•							
BLS	•		•	•	•			•	•	•	•
OAK	•		•	•					•		•
SHD	•		•	•		•			•	•	•
MHD	•		•	•		•			•	•	•



Door images shown in white are available in a variety of textures and materials as noted by the legend.

6'8"



106-817-1 2236



106-817-1P 2236



106-817-2 2236



106-817-3 2236



107-817-1 2237
camber-top



107-817-1P 2237
camber-top



107-817-2 2237
camber-top



107-817-3 2237
camber-top



122-817-X 2264



304-817-2 1640
oval



304-817-3 1640
oval



404-817-1 2248



404-817-2 2248



129-817-1 836



152-817-X 764



450-817-1 848

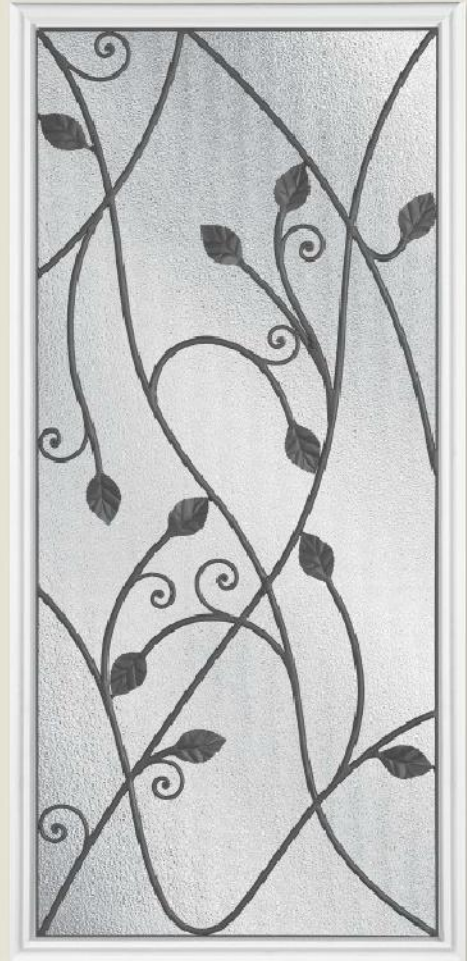

Sienna features a full panel of textured glass which provides a high level of obscurity and diffuses the appearance of the wrought iron from the inside of the home.

tempered pear glass (inside facing)
wrought iron



LEAST OBSCURE 1 2 3 4 5 6 7 8 9 MOST OBSCURE

8
PRIVACY RATING

WOODBIDGE® glass

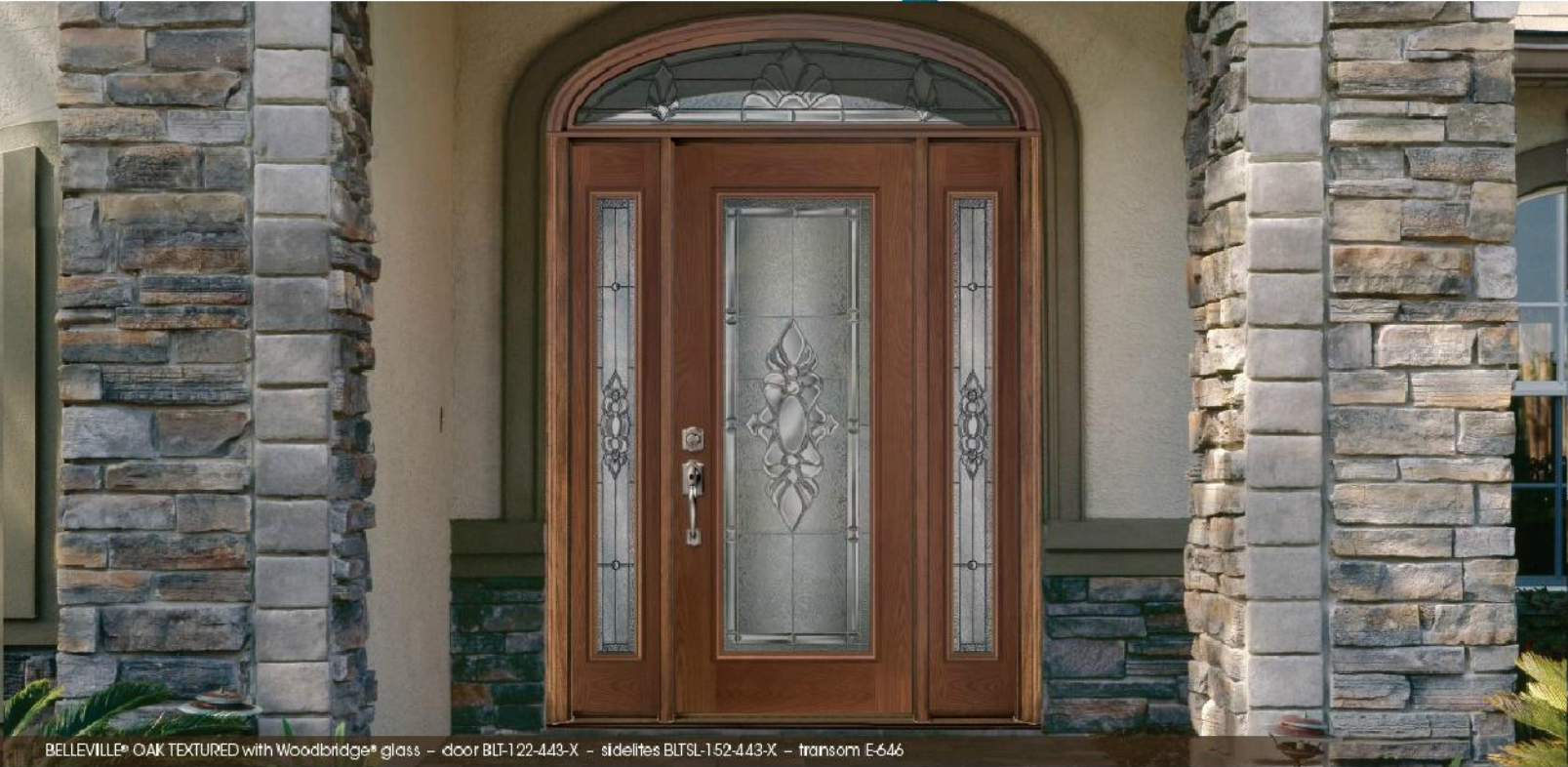

BELLEVILLE® OAK TEXTURED with Woodbridge® glass – door BLT-122-443-X – sidelites BLTSL-152-443-X – transom E-646

													
	122-X	137-3	137-4	137-6	228-3	228-4	228-6	300-X	304-2	304-3	306-1	404-1	404-2
B	122-442-X	137-442-3	137-442-4	137-442-6	228-442-3	228-442-4	228-442-6	300-442-X	304-442-2	304-442-3	306-442-1	404-442-1	404-442-2
P	122-443-X	137-443-3	137-443-4	137-443-6	228-443-3	228-443-4	228-443-6	300-443-X	304-443-2	304-443-3	306-443-1	404-443-1	404-443-2
BMT	•					•							
BLT		•			•						•		•
BFT	•					•			•				•
BLS	•			•	•				•			•	•
OAK	•												•
SHD	•											•	•
MHD	•											•	•

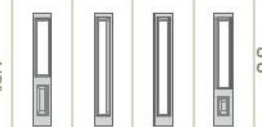
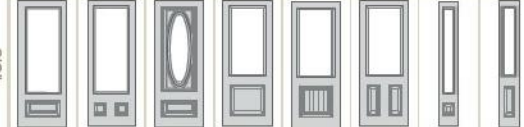
												
	129-1	151-X	152-X	450-1	122-1	122-2	306-2	404-1	404-1P	404-2	151-1	450-1
B	129-442-1	151-442-X	152-442-X	450-442-1	122-442-1	122-442-2	306-442-2	404-442-1	404-442-1P	404-442-2	151-442-1	450-442-1
P	129-443-1	151-443-X	152-443-X	450-443-1	122-443-1	122-443-2	306-443-2	404-443-1	404-443-1P	404-443-2	151-443-2	450-443-1
BMT	•											
BLT	•											
BFT	•	•										
BLS	•			•	•			•	•	•	•	•
OAK	•											•
SHD	•										•	•
MHD	•										•	•



BMT
Belleville® Mahogany Textured

BLT
Belleville® Oak Textured

BFT
Belleville® Fir Textured

BLS
Belleville® Smooth

OAK
Oakcraft®

SHD
Sta-Tru® HD Steel

MHD
Masonite® HD Steel



C38-645, C38-646 transom



C-645, C-646 transom



S-645, S-646 transom



E-645, E-646 transom



T-645, T-646 transom

Door images shown in white are available in a variety of textures and materials as noted by the legend.

6'8"



122-442-X 2264



137-442-3 2210
cambertop



137-442-4 2210
cambertop



137-442-6 2210
cambertop



228-442-3 2210



228-442-4 2210



228-442-6 2210



300-442-X 2057
oval



304-442-2 1640
oval



304-442-3 1640
oval



306-442-1 1555
oval



404-442-1 2248



404-442-2 2248



129-442-1 836



152-442X 764



450-442-1 848



Glass shown with brass coming.
Platinum also available.



- granite glass
- clear beveled glass
- glue chip glass
- brass coming



LEAST OBSCURE 1 2 3 4 5 6 7 8 9 MOST OBSCURE





BELLEVILLE® MAHOGANY TEXTURED with Zavalla® glass - door BMT-122-537-X - sidelites BMTSL-152-537-X

	"8,9"						"0,8"								
	122-X	404-1	404-2	151-X	152-X	450-1	122-1	122-2	404-1	404-1P	404-2	810-X	151-1	450-1	852-X
P	122-537-X	404-537-1	404-537-2	151-537-X	152-537-X	450-537-1	122-537-1	122-537-2	404-537-1	404-537-1P	404-537-2	810-537-X	151-537-1	450-537-1	852-537-X
BMT	•	•			•	•	•					•	•	•	•
BLT	•		•		•	•			•			•		•	•
BFT	•	•		•		•									
BLS	•	•	•		•	•	•		•	•		•	•	•	•
OAK	•		•		•	•					•			•	•
SHD	•	•	•		•	•		•			•	•	•	•	•
MHD	•	•	•		•	•		•			•	•	•	•	•

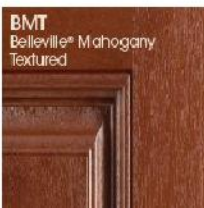

Door images shown in white are available in a variety of textures and materials as noted by the legend.

6'8"



122-537-X 2264



404-537-1 2248



404-537-2 2248



152-537-X 764



450-537-1 848

8'0"



810-537-X 2280



852-537-X 880

Zavalla glass options are limited only by your imagination. No lefts or rights, no ups and downs, no rules—each Zavalla insert is designed to be rotated. The orientation and arrangement of each insert in your door system is entirely reflective of your own personal wishes.

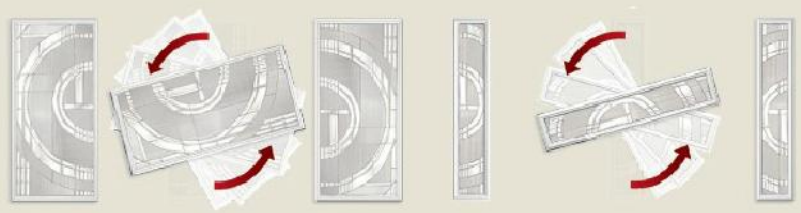
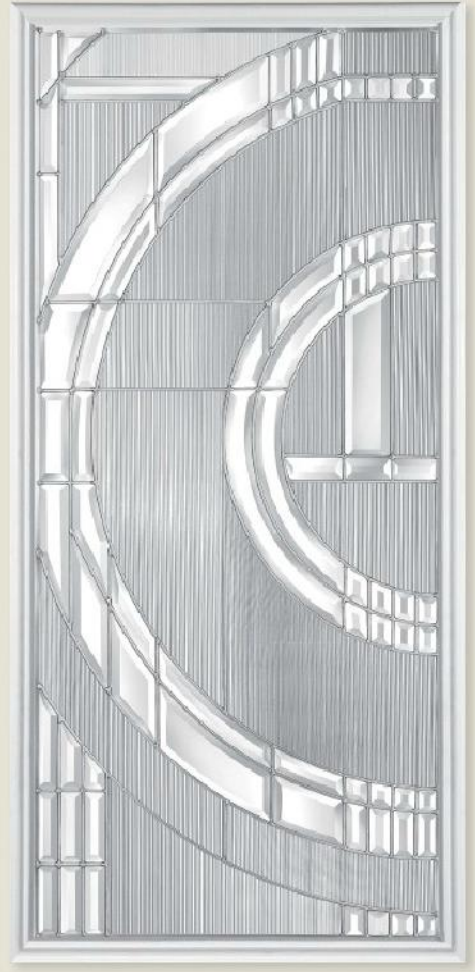

DOOR COMBINATIONS	Option 1	Option 2	Option 3	Option 4	Option 5	Option 6	Option 7	Option 8
D	()	()						
S D	(())	()) (
D S	(())	()) (
S D S	(())	(())	(())) () ((())) ((())
D D	(())	(())	(())					

D = doorite S = sidelite
*Note: Option 3 will not create a perfect circle



Masonite offers a **full lite** perfect circle configuration for Zavalla. Please specify when ordering, as different part numbers are required.

clear beveled glass
narrow reed
platinum caming

LEAST OBSCURE 1 2 3 4 5 6 7 8 9 MOST OBSCURE

7 PRIVACY RATING

CLEAR LITES door & glass

Imagine a blind you don't have to dust or clean. Our blinds are built into efficient sealed units protected with tempered glass. A single touch easily opens/closes blinds for privacy and light exposure.

Our venting inserts are virtually maintenance free and will not yellow or crack.

Internal Blinds 010 tilt only 01RL raise&lower-tilt												clear or Low-E glass		
CLEAR OR LOW-E GLASS														
	B106-010-2	B106-09F-2	B120-010-X	B122-010-X	B120-150E1-X	B122-150E1-X	B160-010-2	B404-010-2	B129-010-1	B152-010-X	B450-010-1			
	B106-01RL-2		B120-01RL-X	B122-01RL-X		B160-01RL-2						B610-01RL-X	B620-01RL-X	
BMT														
BLT	*	*	*	*	*	*	*	*	*	*	*	*	*	
BFT	*	*	*	*	*	*	*	*	*	*	*	*	*	
BLS	*	*	*	*	*	*	*	*	*	*	*	*	*	
OAK	*	*	*	*	*	*	*	*	*	*	*	*	*	
SHD	*	*	*	*	*	*	*	*	*	*	*	*	*	
MHD	*	*	*	*	*	*	*	*	*	*	*	*	*	
MUS	*	*	*	*	*	*	*	*	*	*	*	*	*	

Venting Inserts 010 one lite												I standard internal grille		clear or Low-E glass	
CLEAR OR LOW-E GLASS															
	V106-010-2	V120-010-X	V122-010-X	V160-010-2	V404-010-2	V129-010-1	V151-010-X	V106-12F-2	V120-18F-X	V122-18F-X	V160-12F-2	V129-04F-1	V151-06F-X		
BMT															
BLT	*	*	*	*	*	*	*	*	*	*	*	*	*		
BFT	*	*	*	*	*	*	*	*	*	*	*	*	*		
BLS	*	*	*	*	*	*	*	*	*	*	*	*	*		
OAK	*	*	*	*	*	*	*	*	*	*	*	*	*		
SHD	*	*	*	*	*	*	*	*	*	*	*	*	*		
MHD	*	*	*	*	*	*	*	*	*	*	*	*	*		
MUS	*	*	*	*	*	*	*	*	*	*	*	*	*		

External Grille Inserts E standard external grille ^{††}												clear or Low-E glass		
CLEAR OR LOW-E GLASS														
	106-09E-2	107-09E-2	120-10E1-X	122-10E1-X	120-15E-X	122-15E-X	135-05E-4	137-05E-4	160-09E-2	215-03E-2	215-06E-2	129-03E-1	152-05E-X	615-02E-1
BMT														
BLT	*	*	*	*	*	*	*	*	*	*	*	*	*	
BFT	*	*	*	*	*	*	*	*	*	*	*	*	*	
BLS	*	*	*	*	*	*	*	*	*	*	*	*	*	
OAK	*	*	*	*	*	*	*	*	*	*	*	*	*	
SHD	*	*	*	*	*	*	*	*	*	*	*	*	*	
MHD	*	*	*	*	*	*	*	*	*	*	*	*	*	
MUS	*	*	*	*	*	*	*	*	*	*	*	*	*	

species

- BMT** Belleville® Mahogany Textured
- BLT** Belleville® Oak Textured
- BFT** Belleville® Fir Textured
- BLS** Belleville® Smooth
- OAK** Oakcraft®
- SHD** Sta-Tru® HD Steel
- MHD** Masonite HD Steel
- MUS** Masonite Utility Steel



[†]Available clear or Low-E argon

MHD and SHD doors are available with wood-edge or steel-edge construction. MUS doors are wood-edge only. Wood-edge sidelites are utilized on all MUS, MHD and SHD door units. [†]Almond stainable frames are not available. ^{*}Mahogany tinted frames are not available, however BMT doors are physically compatible with BLT inserts. ^{††}Simulated divided lite options using extruded PVC lineals are available in select configurations.



One Lite 010 standard one lite							clear or Low-E glass					
CLEAR OR LOW-E GLASS	clear glass only											
106-010-2	107-010-2	108-010-X	114-010-X	120-010-X	122-010-X	135-010-4	136-010-8	137-010-4	160-010-2	215-010-2	*217-010-2	228-010-4
BMT	•				•							
BLT	•	•		•	•	•		•	•	•		•
BFT	•		•		•					•		•
BLS	•	•	•	•	•	•		•	•	•		•
OAK	•	•	•	•	•	•	•	•	•	•		•
SHD	•	•	•	•	•	•	•	•	•	•	•	•
MHD	•	•	•	•	•	•	•	•	•	•	•	•
MUS	•	•	•	•	•	•	•	•	•	•	•	•

CLEAR OR LOW-E GLASS	clear glass only										
300-010-X	304-010-3	404-010-2	680-010-4	129-010-1	151-010-X	152-010-X	450-010-1	615-010-1	810-010-X	820-010-X	852-010-X
BMT				•	•	•	•	•	•	•	•
BLT	•	•	•	•	•	•	•	•	•	•	•
BFT				•	•	•	•	•	•	•	•
BLS	•	•	•	•	•	•	•	•	•	•	•
OAK	•	•	•	•	•	•	•	•	•	•	•
SHD	•	•	•	•	•	•	•	•	•	•	•
MHD	•	•	•	•	•	•	•	•	•	•	•
MUS	•	•	•	•	•	•	•	•	•	•	•

Q1 Available Q1 2014 *Profile for 217 lite frame is unique. Please specify 152 smooth PVC sidelites to match this lite frame.



clear glass

- BMT
- BLT
- BFT
- BLS
- OAK
- SHD
- MHD

Internal Grilles

Internal Grille Types**
(specify grille type when ordering)
All grille styles are not available in all lite sizes. See price book for detailed offering list.

A
White
Slimline
5/16"



B
White
Traditional
5/8"



C
White Wide
Traditional
7/8"



D
White
Georgian
5/8"



E
Sandlewood
Traditional
5/8"



H
Tudor
5/8"



L
Almond Wide
Traditional
7/8"



M
Antique
Black
5/8"



Internal Grille Inserts I standard internal grille P prairie internal grille C craftsman internal grille clear or Low-E glass

CLEAR OR LOW-E GLASS	I standard internal grille				P prairie internal grille				C craftsman internal grille				clear or Low-E glass			
	106-04I-2	106-09I-2	107-09I-2	114-10I-X	120-08I-X	122-08I-X	120-10I-X	122-10I-X	120-15I-X	122-15I-X	135-05I-4	160-09I-2	215-02I-2	215-03I-2	215-04I-2	215-04I-2
BMT
BLT
BFT
BLS
OAK
SHD
MHD
MUS

CLEAR OR LOW-E GLASS	I standard internal grille				P prairie internal grille				C craftsman internal grille				clear or Low-E glass			
	228-06I-4	404-04I-2	404-06I-2	404-08I-2	404-12I-2	129-02I-1	129-03I-1	151-04I-X	132-04I-X	151-09I-X	152-08I-X	450-02I-1	450-03I-1	450-04I-1	615-02I-1	
BMT
BLT
BFT
BLS
OAK
SHD
MHD
MUS

CLEAR OR LOW-E GLASS	I standard internal grille				P prairie internal grille				C craftsman internal grille				clear or Low-E glass			
	810-12I-X	820-12I-X	810-18I-X	820-18I-X	852-06I-X	106-09P-2	120-09P-X	122-09P-X	160-09P-2	404-09P-2	129-06P-1	151-06P-X	152-06P-X	450-06P-1		
BMT
BLT
BFT
BLS
OAK
SHD
MHD
MUS

CLEAR OR LOW-E GLASS	I standard internal grille				P prairie internal grille				C craftsman internal grille				clear or Low-E glass				
	106-03C-2	106-04C-2	120-03C-X	122-03C-X	120-04C-X	122-04C-X	404-03C-2	404-04C-2	129-03C-1	151-03C-X	152-03C-X	450-03C-1	810-03C-X	810-04C-X	820-03C-X	820-04C-X	852-03C-X
BMT
BLT
BFT
BLS
OAK
SHD
MHD
MUS

*Available clear or Low-E argon
MHD doors are available with wood-edge or steel-edge construction. MUS doors are wood-edge only. Wood-edge sidelites are utilized on all MUS and MHD door units. †Almond stainable frames are not available. *Mahogany tinted frames are not available, however, BMT doors are physically compatible with BLT inserts. ††Simulated divided lite options using extruded PVC lineals are available in select configurations.



SDL

Create Your Own Glass Design with Your Choice of Masonite Glass SDL Kit Options



With our SDL (Simulated Divided Lite) kit you can easily create a new look for a Masonite clear or textured glass door. Intuitively designed, the pieces snap into place to form the grid configuration and align perfectly with Masonite lite frames.

- smooth or textured available: white, almond and mahogany
- standard or Prairie configurations available
- SDLs can be painted or stained
- feature strong, weather-resistant adhesive tape
- kit includes set for inside and outside of door

W White A Almond M Mahogany

Your Glass



Your SDL Kit



SDL Simulated Divided Lite 6'8" doors & sidelites

FRAMES	106-S04-2	106-S06-2	106-S09-2	160-S04-2	160-S06-2	160-S09-2	120-S04-X	120-S06-X	120-S08-X	120-S09-X	120-S10-X	120-S12-X	120-S15-X	122-S04-X	122-S06-X	122-S08-X	122-S09-X	122-S10-X	122-S12-X	122-S15-X	
W	•	•	•	•	•	•	•	•	•	•	•	•	•	•	•	•	•	•	•	•	•
A	•	•	•											•	•	•	•	•	•	•	•
M	•	•	•											•	•	•	•	•	•	•	•

FRAMES	215-S02-2	215-S03-2	215-S04-2	215-S06-2	404-S04-2	404-S06-2	404-S08-2	404-S09P-2	129-S02-1	129-S03-1	151-S03-X	151-S04-X	151-S05-X	151-S06P-X	152-S03-X	152-S04-X	152-S05-X	152-S06P-X	450-S02-1	450-S03-1	450-S04-1	450-S06P-1	615-S02-1
W	•	•	•	•	•	•	•	•	•	•	•	•	•	•	•	•	•	•	•	•	•	•	•
A	•	•	•		•	•	•	•	•	•	•	•	•	•	•	•	•	•	•	•	•	•	•
M	•	•	•		•	•	•	•	•	•	•	•	•	•	•	•	•	•	•	•	•	•	•

8'0" doors & sidelites

FRAMES	404-S04-X	404-S06-X	404-S09P-X	404-S10-X	122-S04-X	122-S06-X	122-S08-X	122-S09-X	122-S09P-2	122-S10-2	122-S12-2	122-S15-2	810-S04-X	810-S06-X	810-S08-X	810-S09-X	810-S10-X	810-S12-X	810-S15-X	810-S18-X	810-S04P-X
W	•	•	•	•	•	•	•	•	•	•	•	•	•	•	•	•	•	•	•	•	•
A	•	•	•	•	•	•	•	•	•	•	•	•	•	•	•	•	•	•	•	•	•
M	•	•	•	•	•	•	•	•	•	•	•	•	•	•	•	•	•	•	•	•	•

FRAMES	820-S04-X	820-S06-X	820-S08-X	820-S09P-X	820-S10-X	820-S12-X	820-S15-X	820-S18-X	820-S09P-X	151-S03-X	151-S04-X	151-S05-X	151-S06P-X	450-S02-1	450-S03-1	450-S04-1	450-S06P-1	852-S03-X	852-S04-X	852-S05-X	852-S06-X	852-S06P-X
W	•	•	•	•	•	•	•	•	•	•	•	•	•	•	•	•	•	•	•	•	•	•
A	•	•	•	•	•	•	•	•	•	•	•	•	•	•	•	•	•	•	•	•	•	•
M	•	•	•	•	•	•	•	•	•	•	•	•	•	•	•	•	•	•	•	•	•	•

Note: Craftsman sizes are designed to fit fiberglass doors only.

Fast-Frame[®] adjustable steel door frames

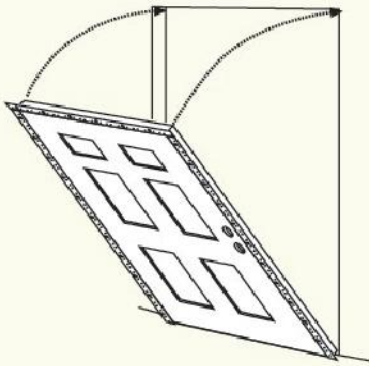

THE ULTIMATE ADJUSTABLE KERFED STEEL DOOR FRAME

FAST-FRAME's advanced design adds a new dimension of flexibility and durability to Masonite's steel entry door line. Developed and manufactured exclusively for Masonite by TIMELY[®], FAST-FRAME features a full 1" of adjustability to accommodate almost any variation in wall construction. This easy-to-install, user-friendly, kerfed steel door frame system is applicable to a full range of residential and commercial applications—wood or steel stud construction. TIMELY's expertise in innovating and manufacturing steel door frame components is second to none. FAST-FRAME is engineered to meet the most stringent code requirements including structural, impact and 90-minute fire ratings.

SILLS

Standard Inswing
 Thermally broken - 5-5/8" width
 Optional extenders for larger wall sizes
 Note: Not for use on outswing applications.



Handicap (ADA)
 Double Slope 4-9/16" & 6-9/16" width 



Tile Face 4-1/4" & 6-1/4" width
 Note: Not for use on outswing applications. 

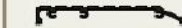

Bumper Outswing 4-9/16" width



TA-1 ADJUSTABLE T-STRIKE

1/4" of adjustment allows for ease of field installations for proper door closure

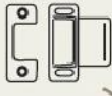

OUTER ADJUSTABLE CLOSURE

20-gauge steel
 2 uprights - 1 header

CLOSURE SPAN ADJUSTMENT CHART

Wall Sizes	A
4-1/2' - 5-1/2' = 1-7/8"	
5-1/2' - 6-1/2' = 2-7/8"	
6-1/2' - 7-1/2' = 3-7/8"	

Wider sizes are available upon request.

WEATHERSTRIPPING

Schlegal foam-filled compression (QEBD500)
 90-minute fire rating

PRIMED WHITE GALVANIZED STEEL

Galvanized 20-gauge steel provides superior corrosion resistance, matches our Masonite HD bright white doors, and is an ideal surface for painting

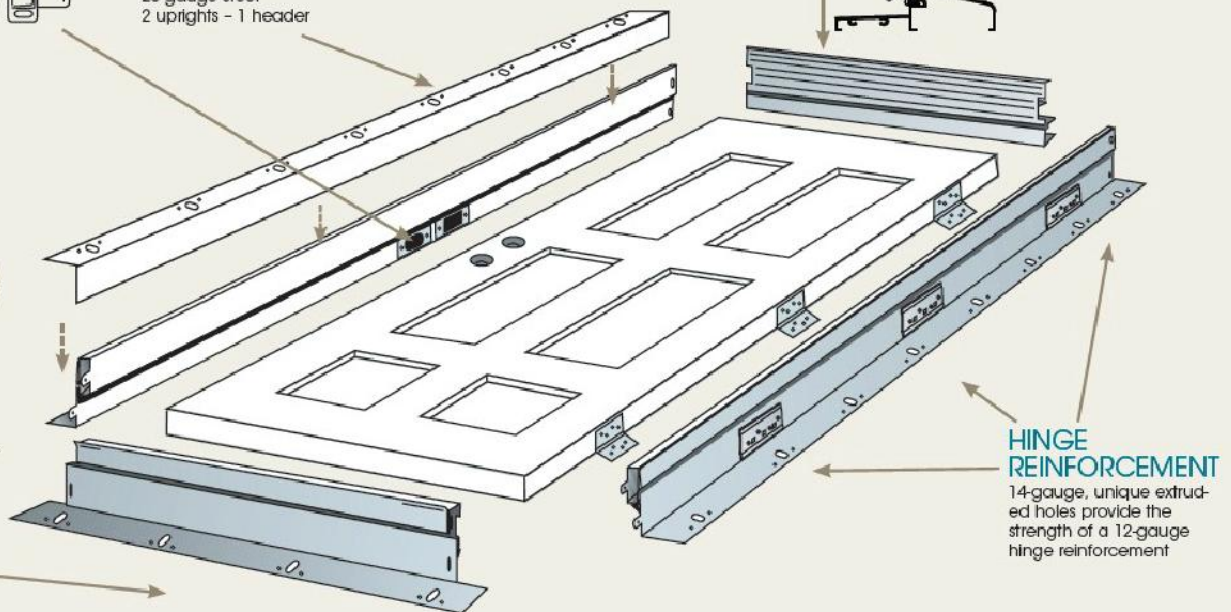

HINGE REINFORCEMENT

14-gauge, unique extruded holes provide the strength of a 12-gauge hinge reinforcement

FAST-FRAME[®] Rough Openings*

Prehung door sizes

	Nominal Door Size	Rough Opening Size (wood stud)
	Width x Height	Width x Height
Single door 	2'0" x 6'8"	25-1/4" x 81-3/8"
	2'6" x 6'8"	31-1/4" x 81-3/8"
	2'8" x 6'8"	33-1/4" x 81-3/8"
	2'10" x 6'8"	35-1/4" x 81-3/8"
	3'0" x 6'8"	37-1/4" x 81-3/8"
Double door 	4'0" x 6'8"	49-1/4" x 81-3/8"
	5'0" x 6'8"	61-1/4" x 81-3/8"
	5'4" x 6'8"	65-1/4" x 81-3/8"
	5'8" x 6'8"	69-1/4" x 81-3/8"
	6'0" x 6'8"	73-1/4" x 81-3/8"

- double door width is with a "z" astragal. if using a 5/8" astragal then add 9/16" to the width
- all dimensions shown are for doors with standard inswing sill. deduct 13/16" for bumper outswing or handicap compliant sill
- add 4" to height for 7'0" height
- add 16" to height for 8'0" height
- premdor spec slabs add 1/4" to height



*Z astragals only available in 6'8" and 8'0" heights
 †Masonite spec

CASING OPTIONS



Wood trim and brickmould can be easily applied to Fast-Frame using nails or trim head screws without the need for custom millwork.

FAST-FRAME CASINGS

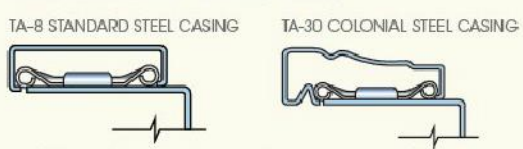

- TA-8 casings enhance any commercial or residential setting.
- TA-30 casings add a special warmth for assisted living, motels, hotels, offices, apartments and homes.

It is recommended that TA-18 retainer clips be used for both casings.

APPLICATIONS

- Multi-Family ■ Assisted Living ■ Motel/Hotel
- House to Garage ■ Garage to Exterior



FIRE LABELS

Up to 90-Minute Fire Ratings available in single and double* configurations
*A 'Z' astragal and flush bolt are required for double fire ratings (sold separately)

CLOSURE TEST

In a 90-minute application, the door will close and latch from 18" if the following Fast-Frame components are used:

- QEBD500 Foam-Filled Compression Weatherstripping
- Factory Sweep • Adjustable T-Strike • Factory Supplied Sills • Self Closing Hinges



MASONITE® HD 6 panel steel door



STRUCTURAL PERFORMANCE AND IMPACT RATING

Design pressure ratings are available for compliance with national, state and local wind load and/or missile requirements. Product tested for structural and impact performance in accordance with TAS 201, 202, and 203. Product approval available under the Florida Department of Community Affairs (FL10357). Please note: Structural and Impact performance requires use of a hurricane grade 5/8" T-astragal for double doors.

DOOR SELECTION

Fast-frame is available in either right- or left-hand inswing or outswing, and is for use with any Masonite steel entry door.

easy to install

Patio & flush-glazed doors



FLUSH-GLAZED BELLEVILLE® with Piedmont® glass

Masonite® Patio System Elegant Designs, Certified Performance

Awe inspiring views and ample natural light are just on the other side of the wall. Why not let them in with a touch of style and a heap of energy saving, dependable performance.

Masonite® Patio door panels feature rich options such as: SpectraWeld® designer glass, flush-glazed fiberglass door panels, and premium frame components to make the ultimate passage from your home to the outdoors.



Upgrade to Flush-Glazed Fiberglass Door Panels More View, Less Maintenance

Wider Viewing Area

- 2'8" and 3'0" full life units are available with up to a 20% wider viewing area

Less Maintenance

- Compact profile holds less dust than conventional frames
- Simple profile is also easier to clean
- Fiberglass door panels will not dent or rust

Outstanding Aesthetics

- No screw holes or plugs
- Clean, simple glazing profile

Less Inventory

- Masonite's full life flush glazed system allows for field assembly, so less inventory is required



elegant

patio designs



Masonite® Patio Door Systems

The Masonite patio door collection features SpectraWeld® technology on select decorative glass panels. This unique system utilizes revolutionary composite material that bonds to the glass and simulates coming without the associated limitations such as panel size, air infiltration, weight and rattling.

Masonite patio systems are available for sale as NFRC certified units in fully assembled or knock-down kits, with Low-E configurations. Door panels are also available in standard and flush-glaze configurations.

The designer collection comes standard with Low-E glass to make the system more energy efficient in both the summer and winter.

TRELLA® glass

Inspired by the gentle arches of a trellis, this unique design frames your beautiful deck, garden, or patio vista and creates an inviting passage to your home or outdoor living area.

configuration options

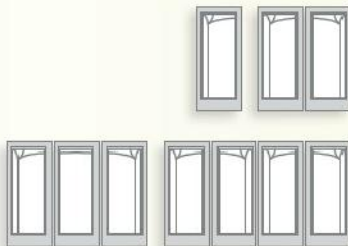

LOW-E IS STANDARD



Image enhanced to show subtle design details; see site photography for best representation.

MONDRIAN® glass

SpectraWeld® and a light ceramic coating are used to create a cubist pattern that is balanced and symmetrical.

This universal design is equally at home in a variety of settings including urban, southwest, and modern motifs.

configuration options

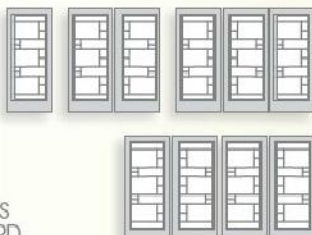

LOW-E IS STANDARD

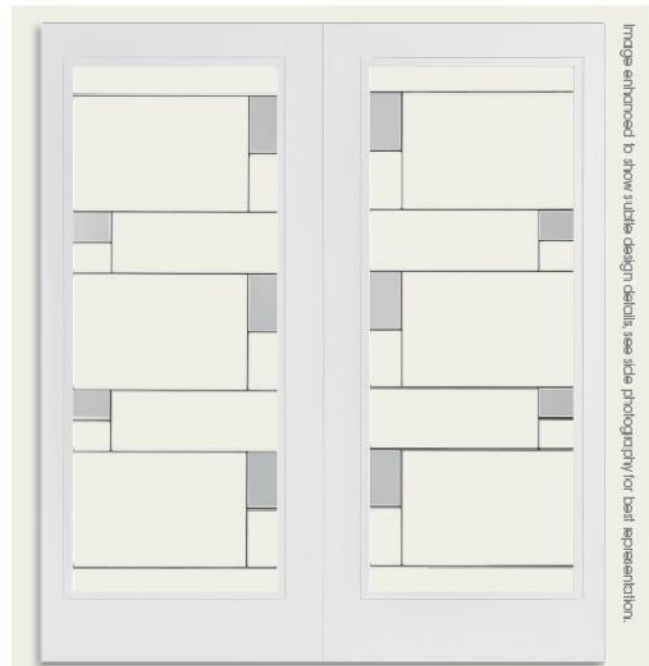

Image enhanced to show subtle design details; see site photography for best representation.

Image enhanced to show subtle design details, see side photography for best representation.



JASMINE® glass



Gentle creeping etched vines entangle around a light pattern to create an opulent gateway to your outdoor retreat.

configuration options

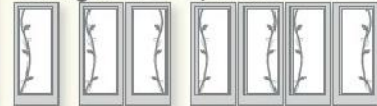

LOW-E IS STANDARD

Image enhanced to show subtle design details, see side photography for best representation.

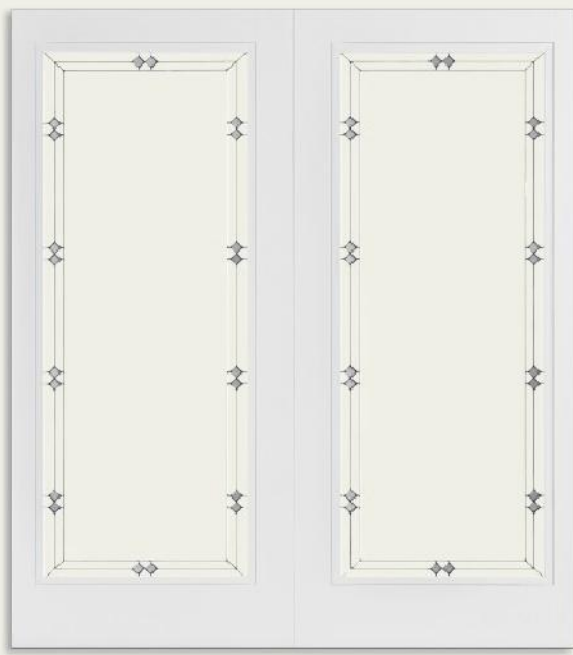

PIEDMONT® glass



An elegant border encases your new patio doors bringing sophistication and elegance without overpowering your view of the outdoors.

configuration options

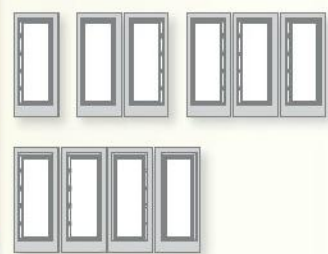

LOW-E IS STANDARD

Image enhanced to show subtle design details, see side photography for best representation.

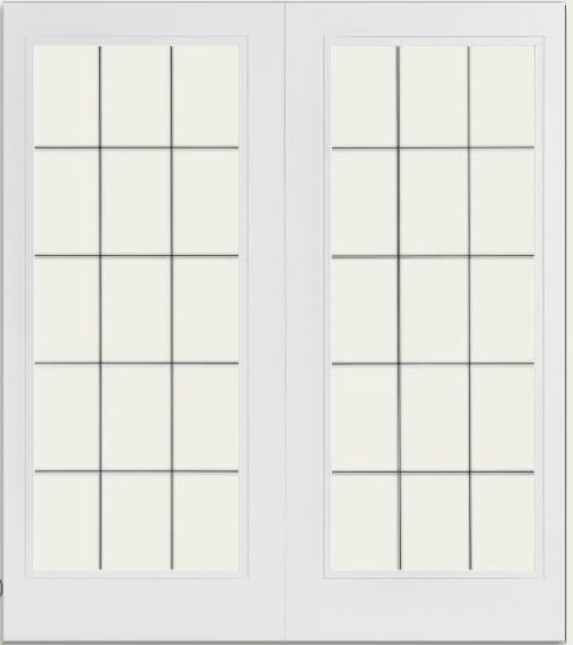

CENTENNIAL 15® glass



The classic leaded 15 pane glass design has been upgraded to be more quiet, energy efficient, and durable through the use of our SpectraWeld® technology.

configuration options

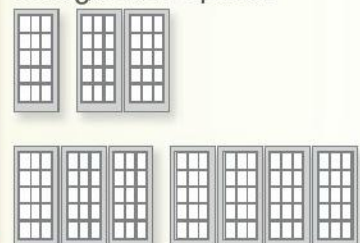

LOW-E IS STANDARD

traditional patio designs



INTERNAL mini-blinds

Our raise / lower mini-blinds are easy to use and maintain. With a quick adjustment you can go from clear views to complete privacy, and the blinds never need to be cleaned.

configuration options



LOW-E IS STANDARD

10 lites



15 lites



10 & 15 Lites

Our 10 and 15 lite units are available in internal and external* grid configurations. Vented sidelites are available.

configuration options

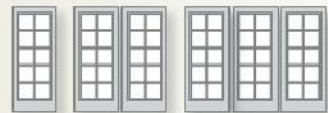

(10L shown)

LOW-E IS STANDARD

*external grids only available in standard glazed systems.

PRAIRIE



ONE LITE & LOW-E clear



Prairie

Our SDL internal bars are used to create a 9 lite prairie style design

Clear and Low-E Clear

Tempered clear glass features a Low-E coating that reflects heat out of the home in the summer and locks in heat during the winter. Vented sidelites are available.

configuration options

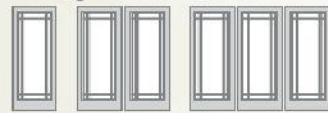

LOW-E IS STANDARD

Traditional clear glass is available.

patio door options

FIBERGLASS		STEEL
OAK TEXTURED	BELLEVILLE® SMOOTH	STEEL
 Mix and match high-performing natural woodgrain textured door designs with your choice of decorative glass.	 Sleek look with a variety of door and glass options to choose from, engineered for performance.	 Hot dipped galvanized steel offers superior corrosion resistance and performance.

Wood Door Authenticity	★★★ Fine	★★★ Fine	★★ Good
Woodgrain Texture	Traditional oak	Smooth	Smooth
Edge (Stile) Construction	True square-edge	True square-edge	Interlocking
Edge (Stile) Material	Stainable/paintable	Paintable	Paintable
Finish Options	Stain or paint	Paint	Paint
Durability & Performance	25 years [†]	25 years [†]	5 years [†]
Composite Bottom Rail	✓	✓	✓
Rust Proof	✓	✓	
Dent Proof	✓	✓	
 ENERGY STAR*	✓	✓	✓
Glazing Options	Flush/Standard	Flush/Standard	Standard
Glass Designs	11+	11+	11+
Glazing Assembly	Traditional glazing inserts	Traditional glazing inserts	Traditional glazing inserts

DOOR MATERIAL CHOICES

Flush-Glazed Door Specifications			
Door Material	OAKCRAFT® TEXTURED	BELLEVILLE® SMOOTH	
Facing Color	White	White	
Height Options	6'8", 8'0"	6'8", 8'0"	
Panel Width	2'6"-3'0"	2'0"-3'0"	
Glass Width	20"-26"	14"-26"	
Standard Glazed Door Specifications			
	BELLEVILLE® OAK	BELLEVILLE® SMOOTH	STEEL
Facing Color	Tan	White	White
Height Options	6'8", 8'0"	6'8", 8'0"	6'8", 8'0"
Panel Width	2'6"-3'0"	2'6"-3'0"	2'6"-3'0"
Glass Width	20"-22"	20"-22"	20"-22"

GENERAL DOOR SPECIFICATIONS

Patio Configuration Options					
Patio Configurations	Vented Sidelite (Single or Double)	Single Door	Double Door	Triple Door	Quad Door*
Heights	6'8"	6'8", 8'0"	6'8", 8'0"	6'8", 8'0"	6'8", 8'0"
Widths	13", 16"	2'0"-3'0"	4'0"-6'0"	6'0"-9'0"	8'0"-12'0"
Hinge Options	L,R	L,R	FR, CE	FR, CE	FR, CE
Swing	IS	IS, OS	IS, OS	IS, OS	IS, OS

CONFIGURATION OPTIONS

*A critical component of an ENERGY STAR qualified entryway.
 *Continuous head and sill construction available to 9' width.
 †All warranties are limited.

Door handing chart for Masonite Entry & Patio doors

INSWING		OUTSWING	
<p>Left Hand Right Hand</p> <p>Doors pictured above assume you are standing on the outside of the home.</p>		<p>Left Hand Right Hand</p> <p>Doors pictured above assume you are standing on the outside of the home.</p>	
<p>SINGLE DOORS</p> <p>Exterior LEFT-HAND INSWING Exterior RIGHT-HAND INSWING</p>		<p>SINGLE DOORS</p> <p>Exterior LEFT-HAND OUTSWING Exterior RIGHT-HAND OUTSWING</p>	
<p>WITH LEFT-HAND SIDELITE</p> <p>Exterior LEFT-HAND HINGE SIDE Exterior RIGHT-HAND LOCK SIDE</p>		<p>WITH LEFT-HAND SIDELITE</p> <p>Exterior LEFT-HAND HINGE SIDE Exterior RIGHT-HAND LOCK SIDE</p>	
<p>WITH RIGHT-HAND SIDELITE</p> <p>Exterior LEFT-HAND LOCK SIDE Exterior RIGHT-HAND HINGE SIDE</p>		<p>WITH RIGHT-HAND SIDELITE</p> <p>Exterior LEFT-HAND LOCK SIDE Exterior RIGHT-HAND HINGE SIDE</p>	
<p>WITH DOUBLE SIDELITE</p> <p>Exterior LEFT-HAND INSWING Exterior RIGHT-HAND INSWING</p>		<p>WITH DOUBLE SIDELITE</p> <p>Exterior LEFT-HAND OUTSWING Exterior RIGHT-HAND OUTSWING</p>	
<p>DOUBLE DOORS</p> <p>Exterior LEFT-HAND INSWING Exterior RIGHT-HAND INSWING</p>		<p>DOUBLE DOORS</p> <p>Exterior LEFT-HAND OUTSWING Exterior RIGHT-HAND OUTSWING</p>	

Complete list of handing options available at Masonite.com.



Masonite® fiberglass DOORS

selection & style

BARRINGTON® TRADITIONAL fiberglass door series

	8 P PARLIAMENT WITH ROUND-TOP GLASS	1 P WITH FULL OVAL GLASS	2 P WITH 3/4 OVAL GLASS	2 P WITH 3/4 RECTANGULAR GLASS	3 P WITH 1/2 CAMBER-TOP GLASS	SIDELITE WITH FULL GLASS	SIDELITE WITH 3/4 GLASS
	BAR	BAR	BAR & BRM	BAR & BRM	BAR	BAR	BAR & BRM
6'8"	3'0"	3'0"	3'0"	3'0"	3'0"	1'0", 1'2"	1'0", 1'2"
8'0"	3'0", 3'6"		3'0", 3'6"	3'0", 3'6" (Oak only)	3'0", 3'6"	1'0", 1'2"	1'0", 1'2"
glass option	6'8" 8'0"	6'8" 8'0"	6'8" 8'0"	6'8" 8'0" (oak only)	6'8" 8'0"	6'8" 8'0"	6'8" 8'0"
BR2 glass	204-BR2 205-BR2	301-BR2	303-BR2 302-BR2	405-BR2 123-BR2	411-BR2 412-BR2	154-BR2 853-BR2	451-BR2 153-BR2
BR3 glass	204-BR3 205-BR3	301-BR3	303-BR3 302-BR3	405-BR3 123-BR3	411-BR3 412-BR3	154-BR3 853-BR3	451-BR3 153-BR3
BR4 glass			303-BR4 302-BR4	405-BR4 123-BR1	411-BR4 412-BR4	154-BR4 853-BR4	451-BR4 153-BR4
CB1 glass			303-CB1	405-CB1	411-CB1		451-CB1
						custom glass options	
	CIRCULAR TRANSOM	SHOULDER TRANSOM	ELLIPTICAL TRANSOM	RECTANGULAR TRANSOM	HALF CIRCLE TRANSOM	<ul style="list-style-type: none"> BR2 antique black caming BR3 platinum caming BR4 antique black caming* (not available for 3'6") CB1 clear beveled Clear transoms are available	
compatible door unit sizes	1'0"- 3'0"- 1'0' & 1'2"- 3'0"- 1'2"					3'0"	
BR2 transoms		S-900	E-900	T-900	C38-900		
BR3 transoms	C-725	S-725	E-725	T-725	C38-725		
BR4 transoms							

BARRINGTON® CRAFTSMAN fiberglass door series

	CRAFTSMAN 3 P	CRAFTSMAN SIDELITE		SHOULDER TRANSOM	RECTANGULAR TRANSOM
	BRC & BCM	BRC & BCM	BRC & BCM	compatible door unit sizes	
6'8"	3'0"	1'0", 1'2"		1'0"- 3'0"- 1'0' & 1'2"- 3'0"- 1'2"	
den/fill shelf kit	option shown			BC4 transoms	T-366
SDL kit	option shown			BC5 transoms	T-315
CBT glass	226-CBT		610-CBT	Clear transoms are available	
BC4 glass	226-BC4		610-BC4		
BC5 glass	226-BC5		610-BC5		
CBH glass	226-CBH		610-CBH		
BS1 glass	226-BS1*	226-BS1*	610-BS1*		
	custom glass options				
	<ul style="list-style-type: none"> CBT 3 lite beveled door 1 lite beveled sidelite BC4 antique black caming BC5 antique black caming CBH 6 lite beveled door 2 lite beveled sidelite BS1 clear glass LEA Low-E argon-filled clear glass 			*Note: Upgrade BS1 clear glass to Low-E and argon-filled (LEA) to increase thermal performance and savings.	



BARRINGTON®
Fiberglass Entry Doors

BELLEVILLE®
Fiberglass Entry Doors

BARRINGTON® SIERRA® & FLAGSTAFF® fiberglass door series

	2 P CAMBER-TOP	2 P PLANK CAMBER-TOP	2 P CAMBER-TOP ARCH-TOP	2 P PLANK CAMBER-TOP ARCH-TOP	1 P PLANK CAMBER-TOP	1 P PLANK CAMBER-TOP ARCH-TOP	FLAGSTAFF PLANK	SIDELITE WITH FULL GLASS
	BSN	BSP	BSN	BSP	BSP	BSP	BFS	BSN
6'8"	3'0"	3'0"	3'0"	3'0"	3'0"	3'0"	3'0"	1'0", 1'2"
8'0"	3'0", 3/6"	3'0", 3/6"	3'0", 3/6"	3'0", 3/6"	3'0", 3/6"	3'0", 3/6"	3'0", 3/6"	1'0", 1'2"
fire door option	3'0"	3'0"			3'0"		3'0"	
plank feature	no plank	plank	no plank	plank	plank	plank	plank	

sidelite custom glass options

- BR2 antique black caming
- BR3 platinum caming
- BS1 clear glass
- Pear 116 textured glass
- Iron Springs 918 wrought iron caming
- LEA Low-E Argon filled clear glass

BELLEVILLE® OAK TEXTURED fiberglass door series

	FLUSH	1 P ARCH	2 P SQUARE	2 P CRAFTSMAN	3 P ARCH-TOP	4 P BLANK-TOP	4 P NEW ENGLAND	6 P BLANK-TOP
	BLT	BLT	BLT	BLT	BLT	BLT	BLT	BLT
6'8"	2'0", 2'6", 2'8", 2'10", 3'0"	2'8", 2'10", 3'0"	2'8", 2'10", 3'0"	2'8", 2'10", 3'0"	2'8", 2'10", 3'0"	2'8", 2'10", 3'0"	2'8", 2'10", 3'0"	2'8", 2'10", 3'0"
7'0"	2'0", 2'6", 2'8", 2'10", 3'0"							
8'0"	2'6", 2'8", 2'10", 3'0"		2'8", 2'10", 3'0"					
fire door option	2'0", 2'6", 2'8", 2'10", 3'0"		2'8", 2'10", 3'0"				2'8", 2'10", 3'0"	
glass sizes	120, 122, 300, 810	306	106, 404	215	304, 404	106, 107, 135, 137, 228	106	106, 107, 135, 137, 228

	6 P	6 P CAMBER-TOP*	8 P PARLIAMENT	SIDELITE WITH FULL GLASS	SIDELITE WITH 3/4 GLASS	CRAFTSMAN SIDELITE	SIDELITE WITH 1/2 GLASS
	BLT	BLT	BLT	BLT	BLT	BLT	BLT
6'8"	2'6", 2'8", 2'10", 3'0"	2'8", 2'10", 3'0"	2'10", 3'0"	1'0", 1'2"	1'0", 1'2"	1'0", 1'2"	1'0", 1'2"
7'0"	2'8", 2'10", 3'0"			1'0", 1'2"			
8'0"	2'6", 2'8", 2'10", 3'0"		2'10", 3'0"	1'0", 1'2"	1'0", 1'2"		1'0", 1'2"
fire door option	2'8", 2'10", 3'0"						
glass sizes	106, 120, 122, 228, 404, 810	137, 228	201, 203	151, 152, 852	151, 450	615	129, 450

† Features narrow panel layout. *6 panel camber-top features a straight-grain hardwood texture.
 Available as 20-minute Warnock-Hersey® listed fire door (features an engineered solid core).



selection & style

Masonite® fiberglass DOORS

BELLEVILLE® MAHOGANY TEXTURED fiberglass door series

							
	HOLLISTER 2 P	CHEYENNE 2 P PLANK	6 P	8 P PARLIAMENT	SIDELITE WITH FULL GLASS	SIDELITE WITH 1/2 GLASS	SIDELITE WITH 3/4 GLASS
	BMT	BMT	BMT	BMT	BMT	BMT	BMT
6'8"	2'8", 2'10", 3'0"	2'8", 2'10", 3'0"	2'8", 2'10", 3'0"	2'10", 3'0"	1'0", 1'2"	1'0", 1'2"	1'0", 1'2"
7'0"							
8'0"	2'8", 2'10", 3'0"		2'8", 2'10", 3'0", 3'6"		1'0", 1'2"	1'0", 1'2"	1'0", 1'2"
 fire door option		3'0"	3'0"				
glass sizes	122, 304, 306, 404	106, 107	106, 122, 228, 404, 810	203	151, 152, 852	129, 450	151, 450

BELLEVILLE® FIR TEXTURED fiberglass door series

							
	HOLLISTER 2 P	CRAFTSMAN 2 P	6 P	SIDELITE WITH FULL GLASS	CRAFTSMAN SIDELITE	SIDELITE WITH 3/4 GLASS	SIDELITE WITH 1/2 GLASS
	BFT	BFT	BFT	BFT	BFT	BFT	BFT
6'8"	2'8", 2'10", 3'0"	2'8", 2'10", 3'0"	2'8", 2'10", 3'0"	1'0", 1'2"	1'0", 1'2"	1'0", 1'2"	1'0", 1'2"
7'0"							
8'0"							
 fire door option			2'8", 2'10", 3'0"				
glass sizes	304, 404	215	106, 122, 228	151	615	450	129

† Features narrow panel layout. * Available in beige color fiberglass only.
 Available as 20-minute Warnock-Hershey® listed fire door (features an engineered solid core).



BELLEVILLE®
Fiberglass Entry Doors

Oakcraft®
Wood-grain Textured
FIBERGLASS ENTRY DOORS

Masonite® Belleville Textured, Smooth & Oakcraft Fiberglass Availability Charts

BELLEVILLE® SMOOTH fiberglass door series

	FLUSH	2 P SQUARE	2 P ROMAN	2 P HOLLISTER	CHEYENNE 2 P PLANK	3 P ARCH-TOP	CRAFTSMAN 2 P	4 P BLANK-TOP
	BLS	BLS	BLS	BLS	BLS	BLS	BLS	BLS
6'8"	2'0", 2'6", 2'8", 2'10", 3'0"	2'8", 2'10", 3'0"	2'8", 2'10", 3'0"	2'8", 2'10", 3'0"	2'8", 2'10", 3'0"	2'8", 2'10", 3'0"	2'8", 2'10", 3'0"	2'8", 2'10", 3'0"
7'0"	2'0", 2'6", 2'8", 2'10", 3'0"							
8'0"	2'0", 2'6", 2'8", 2'10", 3'0"	2'8", 2'10", 3'0"	2'8", 2'10", 3'0"	2'8", 2'10", 3'0"	2'8", 2'10", 3'0"			
fire door option	2'0", 2'6", 2'8", 2'10", 3'0"	2'8", 2'10", 3'0"	2'8", 2'10", 3'0"		2'8", 2'10", 3'0"			
glass sizes	120, 122, 300, 810	106, 404	106, 404	122, 304, 306, 404	106, 107, 404	304, 404	215	106, 107, 135, 137, 228

	4 P NEW ENGLAND	6 P BLANK-TOP	6 P	6 P CAMBER-TOP	8 P PARLIAMENT	SIDELITE W/ FULL GLASS	SIDELITE W/ 3/4 GLASS	CRAFTSMAN SIDELITE	SIDELITE W/ 1/2 GLASS
	BLS	BLS	BLS	BLS	BLS	BLS	BLS	BLS	BLS
6'8"	2'8", 2'10", 3'0"	2'8", 2'10", 3'0"	2'6", 2'8", 2'10", 3'0"	2'8", 2'10", 3'0"	2'10", 3'0"	1'0", 1'0", 1'2"	1'0", 1'2"	1'0", 1'2"	1'0", 1'2"
7'0"			2'8", 2'10", 3'0"			1'0", 1'0", 1'2"			
8'0"			2'6", 2'8", 2'10", 3'0"		2'10", 3'0"	1'0", 1'2"	1'0", 1'2"		1'0", 1'2"
fire door option	2'8", 2'10", 3'0"		2'8", 2'10", 3'0"						
glass sizes	106	106, 107, 135, 137, 228	106, 120, 122, 228, 404, 810	137, 228	201, 203	151, 152, 852	151, 450	615	129, 450

OAKCRAFT® fiberglass door series

	FLUSH	3 P ARCH-TOP	4 P BLANK-TOP	4 P NEW ENGLAND	6 P	9 P	SIDELITE WITH FULL GLASS	SIDELITE WITH 3/4 GLASS	SIDELITE WITH 1/2 GLASS
	OAK	OAK	OAK	OAK	OAK	OAK	OAK	OAK	OAK
6'8"	2'0", 2'6", 2'8", 2'10", 3'0"	2'8", 2'10", 3'0"	2'8", 2'10", 3'0"	2'8", 2'10", 3'0"	2'6", 2'8", 2'10", 3'0"	2'8", 2'10", 3'0"	1'0", 1'0", 1'2"	1'0", 1'2"	1'0", 1'2"
7'0"	2'0", 2'6", 2'8", 2'10", 3'0"						1'0", 1'0", 1'2"		1'0", 1'2"
8'0"	2'0", 2'6", 2'8", 2'10", 3'0"				2'6", 2'8", 2'10", 3'0"		1'0", 1'0", 1'2"		1'0", 1'2"
fire door option	2'0", 2'6", 2'8", 2'10", 3'0"				2'8", 2'10", 3'0"				
glass sizes	120, 122, 300, 810	304, 404	106, 107, 135, 137, 228	106, 107, 135, 137, 228	106, 120, 122, 228, 404	136	151, 152, 852	450	129, 450











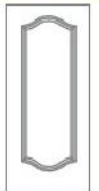
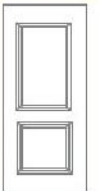
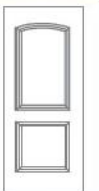

species BMT Belleville® Mahogany Textured BFT Belleville® Fir BLS Belleville® Smooth OAK Oakcraft®

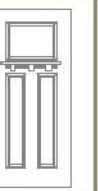
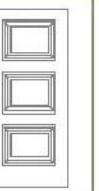

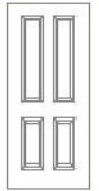
Masonite®
steel
DOORS

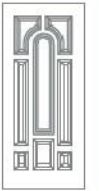
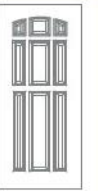

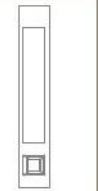
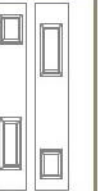





selection & style

MASONITE® HIGH-DEFINITION steel door series

										
	FLUSH	1 P ARCH	2 P SQUARE	2 P ROMAN	2 P PLANK CAMBER-TOP	2 PW/ 23 X 65 C/O	HOLLISTER 2 P	CRAFTSMAN 3 P	3 P EQUAL	3 P ARCH-TOP
	MHD	MHD	MHD	MHD	MHD	MHD	MHD	MHD	MHD	MHD
6'8"	2'0", 2'6", 2'8", 2'10", 3'0", 3'6"	2'8", 2'10", 3'0"	2'8", 2'10", 3'0"	2'8", 2'10", 3'0"	2'8", 2'10", 3'0"		2'8", 2'10", 3'0"	2'8", 2'10", 3'0"	2'8", 2'10", 3'0"	2'8", 2'10", 3'0"
7'0"	2'0", 2'6", 2'8", 2'10", 3'0"		3'0"		3'0"		3'0"		3'0"	
8'0"	2'0", 2'6", 2'8", 2'10", 3'0"					2'8", 2'10", 3'0"				
🔥 fire door option	2'0", 2'6", 2'8", 2'10", 3'0"	2'8", 2'10", 3'0"	2'8", 2'10", 3'0"	2'8", 2'10", 3'0"	2'8", 2'10", 3'0"		2'8", 2'10", 3'0"	2'8", 2'10", 3'0"	2'8", 2'10", 3'0"	2'8", 2'10", 3'0"
glass sizes	120, 122, 300, 810	306	106	106, 107	106, 107	122	404	215	217	304, 404
										
	4 P BLANK-TOP	4 P NEW ENGLAND	6 P	8 P PARLIAMENT	9 P CAMBER-TOP	FLUSH SIDELITE	1 P SIDELITE W/ 9 X 65 C/O	2 P UNIVERSAL SIDELITE	CRAFTSMAN & HOLLISTER SIDELITE	3 P SIDELITE
	MHD	MHD	MHD	MHD	MHD	MHD	MHD	MHD	MHD	MHD
6'8"	2'6", 2'8", 2'10", 3'0"	2'8", 2'10", 3'0"	2'6", 2'8", 2'10", 3'0"	2'8", 2'10", 3'0"	2'8", 2'10", 3'0"	10", 1'0", 1'2"		1'0", 1'2"	1'0", 1'2"	
7'0"	2'6", 2'8", 2'10", 3'0"		2'6", 2'8", 2'10", 3'0"			1'0", 1'2"				1'0", 1'2"
8'0"			2'8", 2'10", 3'0"			10", 1'0", 1'2"	1'0", 1'2"			1'0", 1'2"
🔥 fire door option		2'10", 3'0"	2'8", 2'10", 3'0"	2'8", 2'10", 3'0"	2'8", 2'10", 3'0"					
glass sizes	106, 107, 135, 137	106	106, 120, 122, 404, 810	203	136	151, 152, 852	151	129, 450	615, 450	450, 852

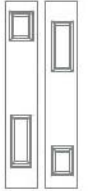

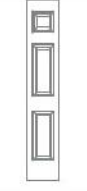
MASONITE® STA-TRU® HD steel door series

								
	FLUSH	2 P ROMAN	2 P PLANK CAMBER-TOP	HOLLISTER ST 2 P	CRAFTSMAN 3 P	3 P EQUAL	3 P ARCH-TOP	4 P BLANK-TOP
	SHD	SHD	SHD	SHD	SHD	SHD	SHD	SHD
6'8"	2'0", 2'6", 2'8", 2'10", 3'0"	2'8", 2'10", 3'0"	2'8", 2'10", 3'0"	2'8", 2'10", 3'0"	2'8", 2'10", 3'0"	2'8", 2'10", 3'0"	2'8", 2'10", 3'0"	2'6", 2'8", 2'10", 3'0"
7'0"	2'0", 2'6", 2'8", 2'10", 3'0"		3'0"	3'0"		3'0"		2'6", 2'8", 2'10", 3'0"
8'0"	2'6", 2'8", 2'10", 3'0"							
 fire door option	2'0", 2'6", 2'8", 2'10", 3'0"	2'8", 2'10", 3'0"	2'8", 2'10", 3'0"	2'8", 2'10", 3'0"	2'8", 2'10", 3'0"	2'8", 2'10", 3'0"		
glass sizes	120, 122, 300, 810	106, 107	106, 107	404	215	217	304, 404	106, 107, 135, 137

							
	6 P	8 P PARLIAMENT	9 P CAMBER-TOP	FLUSH SIDELITE	2 P UNIVERSAL SIDELITE	CRAFTSMAN & HOLLISTER SIDELITE	3 P SIDELITE
	SHD	SHD	SHD	SHD	SHD	SHD	SHD
6'8"	2'6", 2'8", 2'10", 3'0"	2'8", 2'10", 3'0"	2'8", 2'10", 3'0"	10', 1'0", 1'2"	1'0", 1'2"	1'0", 1'2"	
7'0"	2'6", 2'8", 2'10", 3'0"			1'0", 1'2"			1'0", 1'2"
8'0"	2'8", 2'10", 3'0"			10', 1'0", 1'2"			1'0", 1'2"
 fire door option	2'8", 2'10", 3'0"	2'8", 2'10", 3'0"	2'8", 2'10", 3'0"				
glass sizes	106, 120, 122, 404, 810	203	136	151, 152, 852	129, 450	615, 450	450, 852

 Available Q1 2014

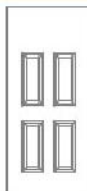
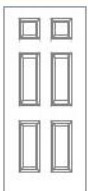
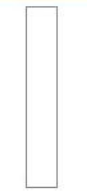
MASONITE® UTILITY steel door series

					
	FLUSH	4 P BLANK-TOP	6 P	FLUSH SIDELITE	2 P SIDELITE
	MUS	MUS	MUS	MUS	MUS
6'8"	2'6", 2'8", 2'10", 3'0"	2'6", 2'8", 2'10", 3'0"	2'6", 2'8", 2'10", 3'0"	10', 1'0", 1'2"	1'0", 1'2"
7'0"					
8'0"					
glass sizes	120, 122, 300	106, 107, 135, 137	106, 120, 122	151, 152	129



HD STEEL MHD 6 panel

Masonite Stain Kit

textured woodgrain doors



Staining your fiberglass entry system has never been easier. The fiberglass staining kit from Masonite comes with everything you need to achieve a high-quality finish.



Complete Stain Kit



- ZAR® exterior water-based polyurethane (Qt.)
- ZAR wood stain (Pt.)
- mineral spirits (4 oz.)
- one synthetic bristle brush (2-1/2")
- two foam brushes (2")
- two stir sticks
- one pair of latex gloves
- cheese cloths
- door staining instructions



Choose Your Stain

	Cherry	Danish Walnut	Early American	Fruitwood	Teak Natural	Dark Mahogany
light						
medium						
dark						

Masonite Tested

Masonite has tested many competing stain and topcoat systems for ease of application, finish quality, and durability, and highly recommends the ZAR system.

Conveniently Packaged

For your convenience we have pre-packaged all the supplies you need to finish your Barrington, Belleville, or Oakcraft door into one convenient kit.

Beautiful Finish

Choose from six distinct colors and customize the shade of your door from light to dark to suit your needs. Finish the project by applying the UV resistant clear satin polyurethane for years of protection and beauty.

Glass Features

Thermal Performance

- 1 Premium decorative glass features energy efficient triple pane construction.
- 2 Clear glass options feature warm edge technology with upgrades into Low-E or Low-E argon filled construction possible on most items.

Certified Construction

- 3 All Masonite decorative glass and over 99% of standard glass options have been tested and certified in accordance to ASTM E 2190 for seal durability. Insulated Glass (IG) certification is required for NFRC certification and ENERGY STAR qualification.

Reinforced Spacer

- 4 Masonite has upgraded its decorative construction to include composite back bedding on large units providing additional support to the decorative core for extreme reliability.

Dependable Frames

- 5 Our Centurion® frames won't discolor in UV exposure and remain stable in high-heat applications. We also offer a paintable/stainable frame in almond or mahogany on select frames.

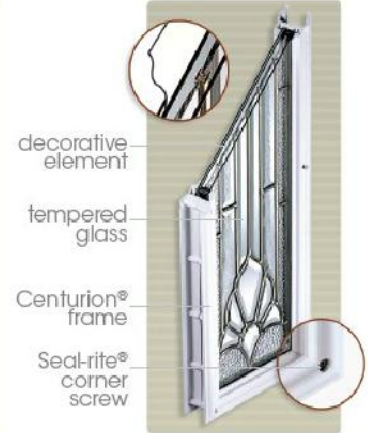

glass shape options for doors displayed

	flush			1 panel arch		2 panel square-top			2 panel roman			Cheyenne 2 panel plank camber-top			Hollister 2 panel			
BMT																		
BLT	•	•	•															
BFT																		
BLS	•	•	•															
OAK	•	•	•															
SHD	•	•	•															
MHD	•	•	•															

	Craftsman	3 panel equal		3 panel arch-top			4 panel blank-top				4 p New England		6 panel blank-top				
BMT																	
BLT	•																
BFT	•																
BLS	•																
OAK	•																
SHD	•	•	•														
MHD	•	•	•														

	6 panel			6 panel camber-top		8 panel Parliament		9 panel	
BMT	•	•	•	•	•				
BLT	•	•	•	•	•				
BFT	•	•	•	•	•				
BLS	•	•	•	•	•				
OAK	•	•	•	•	•				
SHD	•	•	•	•	•				
MHD	•	•	•	•	•				

species	106-2	122-X	228-4	404-2	810-X	137-3	228-3	203-7	201-7	136-8
BMT Belleville® Mahogany Textured	•	•	•	•	•					
BLT Belleville® Oak Textured	•	•	•	•	•					
BFT Belleville® Fir Textured	•	•	•	•	•					
BLS Belleville® Smooth	•	•	•	•	•					
OAK Oakcraft®	•	•	•	•	•					
SHD Sta-Tru® HD Steel	•	•	•	•	•					
MHD Masonite® HD Steel	•	•	•	•	•					











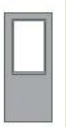



See page 36 for glass index.
Door thumbnails have been generalized.

AVAILABLE CAMING TYPES

















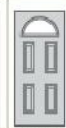

PRIVACY RATING













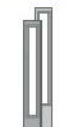

glass series availability																		
Glass Name	Glass Code	Caming	Privacy Rating	106 22" x 36"	107 22" x 37-1/2" roman	122 22" x 64"	135 22" x 10" fan	136 7-1/2" x 18-1/2"	137 22" x 10" camber-top	203 8" x 42" round-top	215 22" x 16"	217 22" x 17"	228 22" x 10"	300 20" x 57" oval	304 16" x 40" 3/4 oval	306 15" x 55" oval	404 22" x 48"	
Alston®	338	AB	7	106-338	107-338	122-338			137-338							304-338		404-338
Aria®	455	CS	8	106-455		122-455												404-455
Aurora™	207	P	7	106-207		122-207				203-207				300-207	304-207			404-207
Brise®	269	SC	7	106-269														404-269
Cuzco®	364	AB	8	106-364		122-364							228-364					404-364
Element®	328	AB	6	106-328	107-328	122-328			137-328		215-328	217-328						404-328
Georgian™	515	B	7	106-515	107-515	122-515		136-515						300-515	304-515	306-515		404-515
	517	P	7	106-517	107-517	122-517		136-517						300-517	304-517	306-517		404-517
	518	AB	7	106-518														
Glaze®	430	B	1	106-430		122-430	135-430											
	433	P	1	106-433		122-433	135-433											
Iron Springs®	918	W	8	106-918		122-918												404-918
Kordella®	686	AB	8	106-686		122-686							228-686					404-686
Marquise®	900	AB	4	106-900	107-900	122-900	135-900		137-900	203-900			228-900	300-900	304-900	306-900		404-900
	777	B	7	106-777		122-777	135-777			203-777				300-777	304-777	306-777		404-777
	778	P	7	106-778		122-778	135-778			203-778				300-778	304-778	306-778		404-778
	779	AB	7	106-779		122-779								300-779	304-779			404-779
Mondrian®	833	SW	8	106-833		122-833												404-833
Naples®	366	AB	8	106-366		122-366				203-366	215-366	217-366	228-366					404-366
Panama®	724	B	6	106-724		122-724	135-724			203-724				300-724	304-724	306-724		404-724
	725	P	6	106-725		122-725	135-725			203-725				300-725	304-725	306-725		404-725
Quattro®	957	W	8	106-957		122-957												404-957
Rockland®	566	AB	6	106-566	107-566	122-566			137-566									404-566
Sienna®	817	W	8	106-817	107-817	122-817												404-817
Woodbridge®	442	B	7			122-442			137-442				228-442	300-442	304-442	306-442		404-442
	443	P	7			122-443			137-443				228-443	300-443	304-443	306-443		404-443
Zavalla®	537	P	7			122-537												404-537
Clear Lites	010	-	0	106-010	107-010	122-010	135-010	136-010	137-010		215-010	217-010	228-010	300-010	304-010	306-010		404-010
Chord	115	-	7	106-115		122-115					215-115		228-115					404-115
Pear	116	-	8	106-116		122-116			137-116		215-116	217-116	228-116					404-116

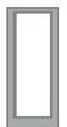

Masonite door specie availability





















																							
code	106-1	106-1P	106-2	106-3	107-1	107-1P	107-2	107-3	122-X	135-4	135-6	136-8	137-3	137-4	137-6	203-7	215-2	217-2	228-3	228-4	228-6	300-X	
BMT				
BLT
BFT					
BLS
OAK					
SHD	
MHD

*MHD doors are available with Wood-Edge or Steel-Edge construction. *Wood-Edge sidelites are utilized on all MHD door units. #Glass shape may appear smaller in 8' door.

													
129 8' x 36'	151 8' x 64'	152 7' x 64'	450 8' x 48'	615 8' x 16'	201 8' x 58' round-top	810 22' x 80'	852 8' x 90'	C half circle transom	S shoulder transom	E elliptical transom	T rectangular transom	C38 half circle transom	A48 48' x 48' accent window
129-338	151-338	152-338	450-338								T-338		
129-455		152-455	450-455										
129-207	151-207	152-207	450-207								T-207		
129-269			450-269										
129-364	151-364	152-364	450-364										
129-328	151-328	152-328	450-328	615-328					S-328		T-328		
129-515	151-515	152-515	450-515					C-645	S-645	E-645	T-645	C38-645	
129-517	151-517	152-517	450-517					C-646	S-646	E-646	T-646	C38-646	
129-518								C-647	S-647	E-647	T-647	C38-647	
129-430	151-430	152-430											
129-433	151-433	152-433											
129-918	151-918	152-918	450-918			810-918	852-918						
129-686	151-686	152-686	450-686										
129-900	151-900	152-900	450-900		201-900	810-900	852-900		S-900	E-900	T-900	C38-900	
129-777	151-777	152-777	450-777		201-777			C-645	S-645	E-645	T-645	C38-645	A48-645
129-778	151-778	152-778	450-778		201-778	810-778	852-778	C-646	S-646	E-646	T-646	C38-646	A48-646
129-779	151-779	152-779	450-779					C-647	S-647	E-647	T-647	C38-647	A48-647
129-833		152-833	450-833										
129-366	151-366	152-366	450-366	615-366		810-366	852-366				T-366		A48-366
129-724	151-724	152-724	450-724		201-724	810-724	852-724	C-724	S-724	E-724	T-724	C38-724	
129-725	151-725	152-725	450-725		201-725	810-725	852-725	C-725	S-725	E-725	T-725	C38-725	
129-957	151-957	152-957	450-957								T-957		
129-566	151-566	152-566	450-566										
129-817	151-817	152-817	450-817										
129-442	151-442	152-442	450-442					C-645	S-645	E-645	T-645	C38-645	
129-443	151-443	152-443	450-443					C-646	S-646	E-646	T-646	C38-646	
	151-537	152-537	450-537			810-537	852-537						
129-010	151-010	152-010	450-010	615-010		810-010	852-010	C-010	S-010	E-010	T-010	C38-010	
129-115	151-115	152-115	450-115	615-115									
129-116	151-116	152-116	450-116	615-116									



Slight bubbles, lines and surface imperfections are all characteristics of handcrafted glass. They distinguish the light transmitted into your home, and are not to be considered defects.

																					
304-2	304-3	306-1	404-1	404-2	129-1	151-X	152-X	450-1	615-1	122-1	122-2	201-7	306-2	404-1	404-1P	404-2	810-X	151-1	450-1	852-X	
.
.
.
.
.
.

inspiring designs

**designed
with precision**

At Masonite, we remain relentlessly committed to delivering product, service and design innovations that enhance beauty and functionality. These innovations create greater value for our customers throughout the world – innovations that will make your home more beautiful. Our leadership and superior products have earned us a reputation that is unsurpassed in the industry. So when it comes to quality, innovation, value, design and beauty, you can confidently put your trust in Masonite. The Beautiful Door Company.

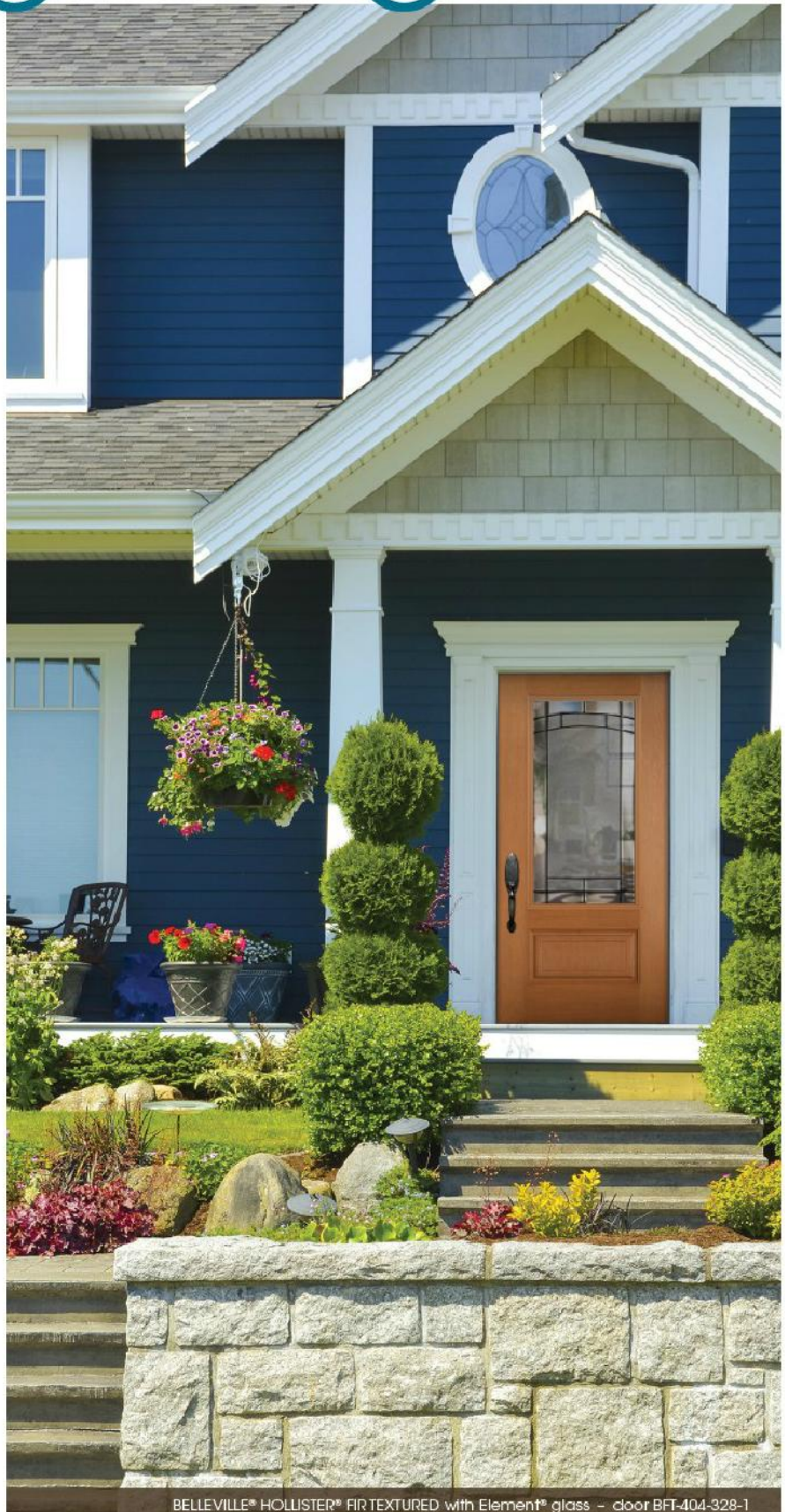

BELLEVILLE® HOLLISTER® FIR TEXTURED with Element® glass – door BFT-404-328-1

Masonite's commitment

At Masonite, employees from all parts of the Company—sales, marketing, research and development, customer service and manufacturing—understand that people love their homes. In the past, homes were purchased to meet functional needs. Today, homes are purchased to meet specific lifestyles and to satisfy the need to create multiple living environments within a single home. To meet these lifestyle needs, Masonite is continually creating new and innovative products that will make every home more beautiful, more valuable and more enjoyable. With the ultimate goal of adding beauty and value to every home, Masonite's products are designed and constructed to exacting standards and specifications. All materials—wood, fiberglass, steel or composites—are engineered and carefully selected to ensure lasting durability and performance. For individuals who are building, renovating or redecorating, Masonite products are certain to beautify and accentuate a wide array of architectural home styles.



 *Masonite*

Design
your door
with

Max

Masonite Xpress ConfiguratorSM



Taking the guess work out makes buying easier. You can create your dream exterior door, then upload a picture of your own home and see what it looks like.



Connect with us

visit your Masonite sales rep.
or scan the QR code now



For full offering visit
masonite.com

cover MASONITE® HD STEEL with Element® glass
door SHD-217-328-2 - sidelites SHDSL-152-328-X - transom S328

Salle d'exposition - Show-room :
1605 Chabanel Ouest - Montréal - QC - H4N 2T7

Tel : (514) FENETRE

Fax : (514) 312 8254

www.450fenetre.com

email : contact@450fenetre.com

For more information contact: 1-800-663-DOOR (1-800-663-3667)

9a - 5p Mon - Fri EST

www.masonite.com

Masonite®, "Masonite, The Beautiful Door.®", Barrington®, Belleville®, Flagstaff®, Oakcraff®, Sierra®, Alston®, Aria®, Aurora®, Brise®, Cuzco®, Element®, Georlgan®, Glace®, Iron Springs®, Kordella®, Madrid®, Marquise®, Mondrian®, Naples®, Panama®, Quattro®, Rockland®, Sienna®, Woodbridge®, Zavalla® and SpectraWeld® are trademarks of Masonite International Corporation.

Please check with your Masonite dealer or distributor for current warranty terms and conditions. Our continuing program of product improvement makes specification, design and product detail subject to change without notice.

86920135 10/13 Printed in Canada ©2013 by Masonite International Corporation